

A "PRINTED" AERIAL FILTER

# Practical Television '6

MAY 1960

AND TELEVISION TIMES

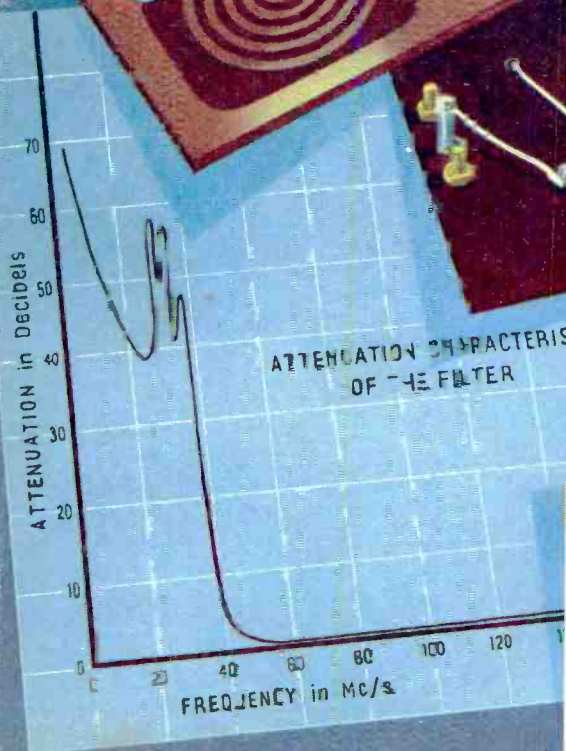

ATTENUATION CHARACTERISTIC OF THE FILTER

## CONTENTS

- A TV TABLE
- FRAME BLOCKING OSCILLATOR
- SERVICING TV RECEIVERS
- AN I.F. WOBBLATOR
- YOUR PROBLEMS SOLVED
- ETC. ETC. ETC.

**More** for less...



**19 Ranges**

<b>D.C. Voltage</b>	<b>A.C. Voltage</b>
0—100mV.	0—10 V.
0—2.5 V.	0—25 V.
0—10 V.	0—100 V.
0—25 V.	0—250 V.
0—100 V.	0—1000 V.
0—250 V.	
0—1000 V.	
<b>D.C. Current</b>	
0—100µA	
0—1mA	
0—10mA	
0—100mA	
0—1 A	

**Resistance**  
0—20.00kΩ  
0—2MΩ

List Price: **£9:10s.**  
complete with Test Leads  
and Crocodile Clips.

Leather Case if required 39/-  
Size: 5 1/2 x 3 3/8 x 1 3/4 in.  
Weight: 1 lb. approx.

MM12

Designed to offer the widest possible range of accurate and reliable measurements at the lowest possible price, the versatility and usefulness of the Multiminor is now further extended by specially designed leads. These new leads, available at no extra cost, will accept crocodile clips or PRODCLIPS.

The Multiminor takes full advantage of the possibilities of printed circuit techniques to achieve outstanding compactness and economy of weight. The scale is clear and open. The fine red coloured pointer and effectively damped movement facilitate easy and rapid reading.

For use in Radio, TV, Electronics, Motor Vehicles, domestic appliances, workshop equipment, you'll find the Multiminor a great little meter.

Use PRODCLIPS with the MULTIMINOR (Pat. No. 748811)

These cleverly designed spring-loaded insulated prods are the complete answer to a long-standing problem. Press the trigger to open, release to grip. Keep your hands free, no matter how difficult of access your test points may be.

15. - per pair.

...with the  
**MULTIMINOR**

Write now for illustrated literature to:—

**AVO LTD**

AVOCET HOUSE - 92-96 VAUXHALL BRIDGE ROAD  
LONDON - S.W.1

Victoria 3404 (12 lines)

A MEMBER OF THE METAL INDUSTRIES GROUP OF COMPANIES

**ERSIN MULTICORE SOLDERS**

for a first class joint every time

Ersin Multicore contains 5 cores of extra-active, non-corrosive Ersin Flux. Prevents oxidation and cleans surface oxides.

SIZE 1 CARTON  
**5/-**



**HANDYMAN'S  
CARTON**

Suitable for 200 average joints. **6d.**

**HOME CONSTRUCTORS  
2/6 PACK**

In addition to the well-known Home Constructors Pack (containing 19ft. of 18 s.w.g. 60/40 alloy) a similar pack is now available containing 40ft. of 22 s.w.g. 60/40 alloy especially suitable for printed circuits.



Wherever precision soldering is essential, manufacturers, engineers and handymen rely on MULTICORE. There's a MULTICORE SOLDER just made for the job you have in hand. Here are some of them.

**SAVBIT TYPE 1 ALLOY**

A specially formulated alloy to reduce the wear of soldering iron bits. Contains 5 cores of non-corrosive Ersin Flux and is ideal for all soldering purposes.



SIZE 1 CARTON 5/-

Available in three specifications.

**BIB WIRE STRIPPER  
AND CUTTER**

Strips insulation without nicking wire, cuts wire cleanly, splits extruding flex. **3/6 each**



**MULTICORE SOLDERS LTD.,**

MULTICORE WORKS, HEMEL HEMPSTEAD, HERTS. (BOXMOOR 3636)

**TELEVISION  
TUBES  
REBUILT**

A NEW GUN IN EVERY TUBE  
BUY DIRECT FROM THE FACTORY!

**12 MONTHS' GUARANTEE**

12" - - - - **£5. 0.0**

14" - - - - **£5. 10.0**

17" - - - - **£6. 10.0**

Immediate dispatch on receipt of Remittance

SPECIAL TERMS TO THE TRADE

Carriage and insurance 12 6 extra

**MARSHALLS for TELEVISION LTD.**

131 St. Ann's Road, Tottenham,  
London, N.15. STAmford Hill 3267

## D.C. OSCILLOSCOPE



**A.C. MAINS 200-250 VOLTS**

**SIMPLIFIED SERVICING PROBLEMS WHEN USING**

**THE 'TESTGEAR' SCOPE**  
**3in. D.C. OSCILLOSCOPE**

Engineered to precision standards, this high-grade instrument is made available at the lowest possible price, incorporating the essential features usually associated with luxury instruments.

This "SCOPE" will appeal particularly to Service Engineers and Amateurs. A high gain, extremely stable differential Y-amplifier (30 mV/C.M.). Provides ample sensitivity with A.C. or D.C. inputs. Especially suitable for measurement of transistor operating conditions where maintenance of D.C. levels is of paramount importance. Push-pull X amplifier; Fly-back suppression; Internal Time-base Scan Waveform available for external use; pulse output available for checking T.V. Line O/P Transformers, etc.; Provision for external X I/P and CRT Brightness Modulation. Size 10in. high, 6 1/2in. wide, 9in. deep. Wgt. 11 lbs. £15.15.0, plus P. & P. 7/6, or 20/- deposit, plus P. & P. 7/6 and 12 monthly payments of 26/6.

**FULL 12 MONTHS' GUARANTEE INCLUDING VALVES AND TUBE.**

## ALIGNMENT ANALYSER TYPE MC12

A.C. mains 200-250V. Provides: "Wobblulator" (Swept Frequency) operation, for FM/TV alignment. Linear frequency sweep up to 12 Mc/s. From 400 kc/s-80 Mc/s. Capacitance Measurement. Two ranges provided 0-80pF and 0-120pF. Special Facility enables true resonant frequency of any tuned cct. I.F. transformer, etc., to be rapidly determined. Cash price £8.19.6, plus 5/- P. & P. H.P. terms

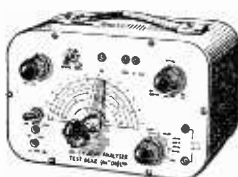

25/- deposit plus 5/- P. & P. and six monthly payments of 21/6.

## WOLSEY 3-ELEMENT FOLDED DIPOLE

I.T.V. Aerial less mounting bracket for External use, complete with 12 yds. of coaxial cable, 15/-; 4 element, 17/6; 5 element, 25/- P. & P. on above, 3/6.

## LINE E.H.T. TRANSFORMER

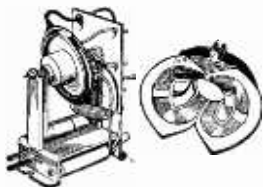

With built-in line and width control, 14 KV. Scan coil, 90° deflection, on ferrite Yokes. Frames O.P. transformer pl. 18 KV. smoothing condenser. Can be used for 14in., 17in. or 21in. tubes. Complete with circuit diagram.

**29/6** Plus 4/- P. & P. Focus Magnet suitable for the above (state tube). 10/- Plus 2/6 P. & P.

## F.M. TUNER UNIT

by famous German manufacturer. Coverage 88-100 Mc/s. Complete with ECC85, size 4in. x 2in. x 2in.

**25/-** P. & P. Circuit Diagram 1/-. FREE with Unit.

10.7 Mc/s. I. F. and Discriminator Coil, 4/- pair.

## MAINS TRANSFORMERS

All with tapped primaries, 200-250 volts, 0-16", 180, 200 v., 60 ma., 6.3 v. 2 amp., 10/6, 320-0-320 v. 75 ma., 6.3 v., 2.5 amp., 5 v., 2 amp., 10/6, 280-0-280, 80 ma. 6.3 v. 2 amp., 6.3 v. 1 amp., 10/6, 350-0-350, 70mA 6.3v 1A, 6.3v 2A 10/6. Postage and packing on the above, 3/-.

## AC/DC POCKET MULTI-METER KIT

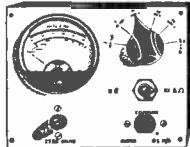

Comprising 2in. moving coil meter scale calibrated in AC/DC volts, ohms and milliamps. Voltage range AC/DC 0-50, 0-100, 0-250, 0-500. Milliamps 0-10, 0-100. Ohms range 0-10,000. Front panel range switch, wire-wound pot (for ohms zero setting), toggle switch, resistor and rectifier. In grey hammer finish case.

**19/6** Plus P. & P. 1/6.

Point to point wiring diagram 1/-. free with kit.

## SIGNAL GENERATORS

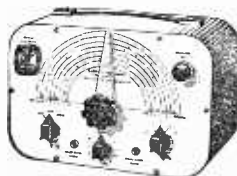

£6.19.6 or 25/- deposit and 6 monthly payments of 21/6. P. & P. 5/- extra. Coverage 100 Kc/s-100 Mc/s on fundamentals and 100 Mc/s to 200 Mc/s on harmonics. Metal case 10in. x 6 1/2in. x 6 1/2in., grey hammer finish. Incorporating three miniature valves and Metal Rectifier. A.C. Mains 200/250. Internal Modulation of 400 c.p.s. to a depth of 20% modulated, or unmodulated R.F., output continuously variable. 100 millivolts. C.W. and mod. switch, variable A.F. output. Incorporating magic-eye as output indicator. Accuracy plus or minus 2%.

Cash £4.19.6 or 25/- deposit and 4 monthly payments of 21/6. Plus Postage and Packing, 5/-. Coverage 120 Kc/s-84 Mc/s. Metal case 10in. x 6 1/2in. x 4 1/2in. Size of scale, 6 1/2in. x 3 1/2in. 2 valves and rectifier. A.C. mains 230-250 v. Internal modulation of 400 c.p.s. to a depth of 30% modulated or unmodulated R.F., output continuously variable. 100 millivolts. C.W. and mod. switch variable A.D. output and moving coil output meter. Grey hammer finished case and white panel. Accuracy plus or minus 2%.

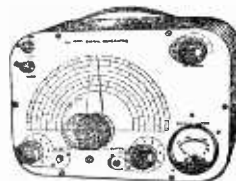

## SIGNAL & PATTERN GENERATOR

£6.19.6. P. & P. 5/- Or 25/- deposit. P. & P. 5/- and 6 monthly payments of 21/6. Coverage 7.6 Mc/s-210 Mc/s. In five bands, all on fundamentals, slow motion tuning audio output, 8 vertical and horizontal bars, logging scale. In grey hammer finished case with carrying handle. Accuracy ± 1% A.C. mains 200-250 v.

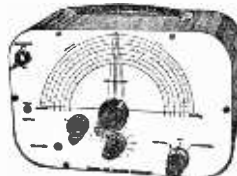

## CHANNEL TUNER

Will tune to all Band I and Band III stations. BRAND NEW by famous manufacturer. Complete with P.C.C. 84 and P.C.F. 80 valves (in series), I.F. 16-19 or 33-3s. Also can be modified as an aerial converter (instructions supplied). Complete with knobs.

**22/6** Plus 3/6 P. & P.

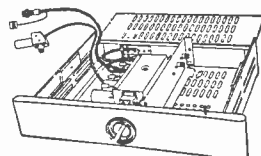

## HEATER TRANSFORMER

To suit the above, 200-250 v., 6/-, Plus 1/6 P. & P.

## 8-WATT PUSH-PULL AMPLIFIER

COMPLETE WITH CRYSTAL MIKE AND 8in. LOUSPEAKER

A.C. mains 200-250 v. Size 10 1/2in. x 6 1/2in. x 2 1/2in. Incorporating 6 valves. H.F. pen., 2 triodes, 2 output pens and rectifier. For use with all makes and type of pick-up and mike. Negative feed back. Two inputs, mike and gram., and controls for same. Separate controls for Bass and Treble lit. Response flat from 40 cycles to 15 Kcs..

± 2 db; 4 db down to 20 Kcs. Output 8 watts at 5% total distortion. Noise level 40 db down all hum. Output transformer tapped for 3 and 15 ohm speech coils. For use with Std. or I.P. records, musical instruments such as Guitars, etc.

**£4.19.6.** P. & P. 7/6. Or 20/- deposit Plus P. & P. 7/6, and 4 monthly payments of 23/-.

## RADIO & T.V. COMPONENTS (Acton) LTD.

23, HIGH STREET, ACTON, LONDON, W.3.

All enquiries S.A.E. GOODS NOT DESPATCHED OUTSIDE U.K.

SPECIALISTS IN THE SUPPLY OF VALVES, TRANSISTORS, AND GERMANIUM DIODES

# BENTLEY ACOUSTIC CORPORATION LTD.

38 CHALCOT ROAD, CHALK FARM LONDON, N.W.1.

Telephone: PRIMROSE 9090

EXPRESS POSTAL SERVICE! ALL ORDERS DESPATCHED SAME DAY AS RECEIVED. FOR ONLY 2/6 EXTRA TELEPHONE FOR THAT URGENT ORDER TO BE DESPATCHED IMMEDIATELY BY OUR SPECIAL C.O.D. SERVICE.

0A2	17/6	6CD6G	36/6	7D8	23/3	25Z4G	9/6	CBL31	23/3	ECF80	11/6	HABC80	PEN46	7/6	U107-	16/7	X61(C)	12/6	
0B2	17/6	6CH6	12/6	7H7	8/-	25Z5	10/6	CCH35	23/3	ECF82	10/6		PEN383	23/3	U191	16/7	X61M	26/6	
0Z4	6/-	6D3	19/11	7R7	12/6	25Z6G	10/6	CK506	6/6	ECH3	26/6	HL23	10/6	PEN453DD	U201	16/7	X63	10/-	
1A3	3/-	6D6	6/6	757	10/6	25Z6GT		CL33	19/3	ECH21	23/3	HL23DD			U251	14/-	X65	12/6	
1A5	6/-	6E5	12/6	7V7	8/6			CV63	10/6	ECH35	9/6		PEN/DD		U281	19/11	X66	12/6	
1A7	15/-	6F1	26/6	7Y4	8/-	27SU	19/11	CY1	18/7	ECH42	10/6	HL41	12/6	4020	33/2	U282	22/7	X76M	14/-
1C5	12/6	6FG6	7/-	7Z4	18/7	28D7	7/-	CY31	16/7	ECH81	9/-	HL41DD		PL33	19/3	U301	23/3	X78	21/3
1D5	9/-	6FGTM	8/-	8D2	3/6	30C1	8/-	DI	3/-	ECH83	13/11			PL36	14/-	U329	14/-	X79	21/3
1D6	10/6	6F11	17/3	8D3	5/6	30F5	7/-	DI5	10/6	ECL80	10/6	HL42DD		PL38	26/6	U339	16/7	X101	33/2
1H5GT	11/-	6F12	5/6	9BVB6	15/3	30FL1	10/-	D63	5/-	ECL82	10/6			PL81	12/6	U403	16/7	X109	17/6
1L4	6/-	6F13	11/6	9D2	4/-	30L1	8/-	D77	5/-	ECL83	19/3	HN309	24/7	PL82	8/-	U404	8/6	XD(1.5)	6/6
1LD5	5/-	6F14	26/6	10C1	12/-	30L15	14/-	DAC32	11/-	EF9	23/3	HVR2	20/7	PL83	9/-	U801	29/10	XFG1	18/-
1LNS	5/-	6F15	15/3	10C2	26/6	30P12	8/-	DAF91	7/6	EF22	14/-	HVR2A	6/-	PL84	12/8	U4020	16/7	XFY12	9/6
1NSGT	11/-	6F16	9/6	10D2	12/-	30P16	12/-	DAF96	9/-	EF36	6/-	KF35	8/6	PL820	18/7	UABC80	9/-	XFY34	17/6
1R5	7/6	6F17	12/6	10F1	26/6	30P11	11/6	DD41	13/11	EF37A	8/-	KK32	21/11	PM2B	12/6	UAF42	9/6	XHI(1.5)	6/6
1S4	9/6	6F32	10/6	10F9	10/6	33A/158M	11/6	DF66	11/-	EF39	5/-	KL35	8/6	PM12	6/6	UB41	12/-	XS(1.5)	6/6
1S5	7/6	6F33	7/6	10LD3	8/6	35A5	30/-	DF66	15/-	EF40	15/-	KL32	24/7	PM12M	21/3	UBC41	8/6	Y63	7/6
1T4	6/-	6G6	6/6	10LD11	8/6	35A5	21/3	DF70	15/-	EF41	9/6	KT2	5/-	PM24M	21/3	UCV81	11/6	Y63	7/6
1U5	10/-	6HG6TG	3/6		15/11	35L6GT	9/6	DF91	6/-	EF42	11/6	KT33C	10/-	PX4	10/6	UBF80	9/-	Z63	10/6
1A7	10/6	6HG6TM	3/6	10P13	15/6	35VW4	7/6	DF96	9/-	EF50(A)	7/-	KT36	29/10	PX25	5/6	UBF89	9/6	Z66	20/-
2P	26/6	6I5G	5/-	10P14	19/3	35Z3	10/6	DF97	9/-	EF50(E)	5/-	KT41	26/6	PY31	16/7	UBL21	23/3	Z77	5/6
2X2	4/6	6I5GTG	5/6	11D3	24/7	35Z5GT	9/6	DH63	8/-	EF54	5/-	KT44	15/-	PY32	17/11	UCB84	14/7	Transistors and diodes	
3A4	7/-	6I5GTM	6/-	12A6	6/6	35Z4	6/6	DH76	6/6	EF73	10/6	KT61	12/6	PY80	7/6	UCFB8	9/-	GD3	7/6
3A5	10/6	6I6	5/6	12AC6	15/3	35Z5GT	9/6	DH77	8/6	EF80	7/-	KT63	7/-	PY81	9/-	UCF80	16/7	GD3	7/6
3B7	12/6	6I7G	6/-	12AD6	17/3	42	23/3	DH101	28/6	EF85	7/-	KT66	15/-	PY82	7/-	UCH21	23/3	GD4	7/6
3D6	5/-	6I7GT	10/6	12AE6	13/11	43	12/6	DH107	13/11	EF86	12/6	KT88	22/6	PY83	9/6	UCH42	9/6	GD5	7/6
3Q4	7/6	6K6GT	8/-	12AH7	8/6	50C5	12/6	DK32	15/-	EF89	9/-	KTW61	8/-	PZ30	19/11	UCH81	9/6	GD6	7/6
3Q5GT	9/6	6K7G	5/-	12AH8	12/6	50CDD6G		DK40	21/3	EF91	5/6	KTW62	8/-	QP21	7/-	UCL82	11/6	GD8	7/6
3S4	7/6	6K7GT	6/-	12AT6	7/6			DK91	7/6	EF92	5/6	KTW63	8/-	QP25	15/-	UCL83	19/3	GD9	7/6
3V4	7/6	6K8GT	12/6	12AT7	8/-	50L6GT	9/6	DK92	10/6	EF97	13/3	KT241	8/-	RQ5150/15		UF41	9/-	GD10	7/6
5R4G	17/6	6K8G	8/-	12AU6	23/3	53KU	19/11	DK96	9/-	EF98	13/3	KT263	10/6			UF42	12/6	GD11	7/6
5U4G	8/6	6K25	19/11	12A7	7/6	72	4/6	DL33	9/6	EK32	8/6	L63	6/-	R12	9/6	UF80	10/6	GD12	7/6
5V4G	11/-	6L1	23/3	12AV6	12/7	75	24/7	DL66	15/-	EL32	5/6	LN152	10/6	R18	14/-	UF85	10/6	OA70	4/-
5Y3G	8/-	6L6G	9/6	12AX7	8/-	77	8/6	DL68	15/-	EL33	12/6	LN309	11/6	R19	19/11	UF86	17/11	OA73	4/-
5Y3GT	7/6	6L6M	12/6	12BA6	8/-	80	8/6	DL92	7/6	EL34	15/-	MH4(C)	7/-	S130	15/-	UF89	9/-	OA79	4/-
5Z3	12/6	6L7GT	12/6	12BE6	10/-	80	9/6	DL94	7/6	EL38	26/6	MH4	7/6	SD6	12/-	UL41	9/-	OA81	4/-
5Z4G	10/6	6L18	13/3	12BH7	21/3	83	15/6	DL96	9/-	EL41	9/-	MHLD6	12/6	SP4(7)	15/-	UL44	26/6	OA86	6/-
5Z4GT	12/6	6L19	23/3	12E1	30/-	83V	12/6	DM70	7/6	EL42	13/11	ML4	12/6	SP41	3/6	UL46	14/6	OA91	5/-
6A7	26/6	6L3D	8/6	12J5GT	4/6	85A2	15/-	EA50	2/-	EL81	12/6	MU14	9/-	SP42	12/6	UL84	8/6	OC16	54/-
6A8	10/-	6LD20	15/11	12J7GT	10/6	150B2	15/-	EAC80	9/-	EL84	8/6	MX40	15/-	SP61	3/6	UM4	17/3	OC44	26/-
6AB7	8/-	6N7	8/-	12K5	17/11	185BT	33/2	EAC9	3/6	EL85	13/11	N7	19/11	SU25	26/6	UM80	15/3	OC45	23/-
6AB8	10/6	6P1	19/3	12K7GT	6/6	185BTA	33/2	EAF42	9/6	EL91	5/-	N78	19/11	SU61	9/6	URIC	9/6	OC65	22/6
6AC7	6/6	6P25	12/6	12K8GT	14/-	304	10/6	EB34	2/6	EL95	10/6	N108	19/11	T41	23/3	U06	19/11	OC66	25/-
6AG5	6/6	6P28	26/6	12Q7GT	6/6	305	10/6	EB41	8/6	EM34	10/-	N308	20/7	TDD4	24/7	U07	16/7	OC70	14/-
6AK5	8/-	6Q7G	8/-	12SA7	8/6	807	7/6	EB91	5/6	EM71	23/3	N339	29/10	TH4B	15/3	U08	26/6	OC71	14/-
6AL5	5/6	6Q7GT	11/-	12SC7	8/6	956	3/-	EB33	23/3	EM80	9/6	P61	3/6	TH41	26/6	U09	7/6	OC72	17/-
6AM6	5/6	6R7G	10/-	12SG7	8/6	1821	16/7	EBC33	7/6	EM81	9/6	PABC80		TH233	33/2	UY1N	18/7	OC73	20/-
6AQ5	8/6	6SA7G	8/6	12SH7	8/6	5763	12/6	EB44	8/6	EM84	10/6		13/11	TH2321	20/-	UY21	16/6	TS1	10/-
6AT6	8/6	6SCT	10/6	12SJ7	8/6	7475	7/6	EBC81	8/-	EM83	37/-	PCC84	8/-	TP22	15/-	UY41	7/6	TS2	21/-
6AUG6	10/6	6SG7GT	8/-	12SK7	8/6	9002	5/6	EBF80	10/-	EY51	9/6	PCC85	9/6	TP25	19/6	UY85	7/-	TS3	24/-
6AV6	12/6	6SH7GT	8/-	12SQ7	12/6	AC/PCN		EBF83	13/11	EY83	16/7	PCC88	23/11	TP2620	33/2	UYM4B	23/3	TS4	24/-
6B7	10/6	6SJ7GT	8/-	12SR7	8/6	5-pin	23/3	EBF89	9/6	EY84	14/-	PCC89	14/-	TY667	13/3	VP2(7)	12/6	TS7	35/-
6BBG	4/6	6SK7GT	8/-	12Y4	10/6	7-pin	15/-	EBL21	23/3	EY86	10/-	PCF80	8/-	U12/14	12/6	VP4(7)	15/-	TS8	40/-
6BBGT	5/-	6SL7GT	8/-	1457	27/10	AC2/PCN		EBL31	23/3	EZ35	6/-	PCF82	11/6	U16	12/-	VP2B	14/6	TS9	30/-
6BA6	7/6	6SN7GT	6/6	18	23/3	DD	26/6	EC52	5/6	EZ40	7/6	PCL82	12/6	U18/20	9/-	VP4B	23/3	TS13	24/-
6BE6	7/6	6SQ7GT	9/-	19AQ5	10/6	AC5PEN		EC54	6/-	EZ41	7/6	PCL83	11/6	U22	8/-	VP13C	7/-	TS14	21/-
6BG6G	23/3	6SS7GT	8/-	19B6G		AC6PEN	23/3	EC70	12/6	EZ80	7/6	PCL84	12/6	U24	29/10	VP23	6/6	TS17	30/-
6BH6	9/-	6U4GT	12/6		23/3	AC6PEN	23/3	EC92	13/3	EZ81	7/6	PEN4A	23/2	U25	17/11	VP41	6/6	XA101	23/-
6B16	7/6	6U5G	7/6	19H1	10/-	AC/SG	7/6	ECC32	10/6	FC2A	24/7	PENB4	26/6	U26	10/-	VR105	9/-	XA102	26/-
6BQ7A	15/6	6U7G	8/6	20D1	15/3	AC/TP	33/2	ECC33	8/6	FC4	15/-	PEN4DD		U31	9/6	VR150	9/-	XA103	15/-
6BR7	23/3	6V6G	7/11	20F2	26/6	AC/VPI	15/3	ECC34	24/7	FC13	26/6	PEN25	26/6	U33	26/6	VT61A	5/-	XA104	18/-
6BW6	10/6	6V6GTG	8/-	20L1	26/6	ATP	14/6	ECC34	8/6	FC13C	26/6	PEN25	19/11	U35	26/6	VT501	5/-	XA102	15/-
6BW7	7/6	6X4	6/6	20P1	26/6	AZ1	18/7	ECC40	23/3	FW4/500	9/-	PEN36C		U37	26/6	W61M	26/6	XB103	14/-
6BX6	7/6	6X5GT	6/-	20P3	23/3	AZ11	10/6	ECC81	8/-			PEN40DD		U43	9/6	W76	6/6	XB104	10/-
6C4	7/6	6X30L2	10/-	20P5	23/3	AZ41	13/11	ECC82	7/6	FW4/800	9/-			U45	9/6	W81M	6/6	XC101	17/-
6C5G	6/6	7A7	12/6	25A6G	11/-	B36	24/7	ECC83	8/-					U50	8/6	W107	15/3	XC131	16/-
6C6	6/6	7B6	21/3	25L6GT	10/-	BL63	7/6	ECC84	9/6	G230	10/6	PEN44	19/6	U52	8/6	W27M	18/7	XC141	44/-
6C8	12/6	7B7	8/-	25U4	16/7	C1	12/6	ECC85	8/6	G232	10/6	PEN45	19/6	U54	19/11	X24M	24/7	XC142	55/-
6C9	12/6	7C5	8/-	25Y5	10/6	C1C	12/6	ECC88	23/3	GZ34	14/-	PEN45DD		U76	6/6	X31	26/6	XD901	26/9
6C10	10/6	7C6	8/-	25Y5G	10/6	CBL1	26/6	ECC91	5/6	H63	12/5			U78	6/6				

# FROM YOUR POINT OF VIEW...

Midland "New Alumina" rebuilt C.R.T.'s, completely rescreened and aluminised offer you the finest value available today! The ever growing demand for these thoroughly reliable tubes is *your* assurance of satisfaction and service.

## Now POPULAR TUBES

at POPULAR PRICES . . .

more Midland "rebuilt"—the tubes you can trust, at amazingly low cost

All types carry a 12-month guarantee and are available off the shelf NOW. Contact—



**MIDLAND Tubes Ltd.** 37, GEORGE STREET, MANCHESTER, I.

Telephone: CENTRAL 4568/9

# FREE TO AMBITIOUS ENGINEERS

— THE LATEST EDITION OF ENGINEERING OPPORTUNITIES

### Have you sent for your copy?

ENGINEERING OPPORTUNITIES is a highly informative 156-page guide to the best paid engineering posts. It tells you how you can quickly prepare at home for a recognised engineering qualification and outlines a wonderful range of modern Home Study Courses in all branches of Engineering. This unique book also gives full details of the Practical Radio & Electronics Courses, administered by our Specialist Electronics Training Division—the B.I.E.T. School of Electronics, explains the benefits of our Employment Dept. and shows you how to qualify for five years promotion in one year.

### We definitely Guarantee

**"NO PASS — NO FEE"**

Whatever your age or experience, you cannot afford to miss reading this famous book. If you are earning less than £20 a week, send for your copy of "ENGINEERING OPPORTUNITIES" today—FREE.

**BRITISH INSTITUTE OF ENGINEERING TECHNOLOGY** (Incorporating E.M.I. Institutes)  
(Dept. SE/20), 29 Wright's Lane, London, W.8

### WHICH IS YOUR PET SUBJECT?

Mechanical Eng.,  
Electrical Eng.,  
Civil Engineering,  
Radio Engineering,  
Automobile Eng.,  
Aeronautical Eng.,  
Production Eng.,  
Building, Plastics,  
Draughtsmanship,  
Television, etc.

### GET SOME LETTERS AFTER YOUR NAME!

A.M.J. Mech.E.  
A.M.I.C.E.  
A.M.I. Prod.E.  
A.M.I.M.I.  
L.I.O.B.  
A.F.R. Ae.S.  
B.Sc.  
A.M. Brit. I.R.E.  
City & Guilds  
Gen. Cert. of Education  
Etc., etc.

### PRACTICAL EQUIPMENT

Basic Practical and Theoretic Courses for beginners in Radio, T.V. Electronics, Etc., A.M. Brit. I.R.E. City & Guilds Radio Amateurs' Exam. R.T.E.B. Certificate P.M.G. Certificate Practical Radio Radio & Television Servicing Practical Electronics Electronics Engineering Automation

### INCLUDING TOOLS!

The specialist Electronics Division of B.I.E.T. (Incorporating E.M.I. Institutes) NOW offers you a real laboratory training at home with practical equipment. Ask for details.

### B.I.E.T. SCHOOL OF ELECTRONICS



### POST COUPON NOW!

Please send me your FREE 156-page 'ENGINEERING OPPORTUNITIES' (Write if you prefer not to cut page)

NAME .....

ADDRESS .....

SUBJECT OR EXAM THAT INTERESTS ME ..... (SE/20)

**THE B.I.E.T. IS THE LEADING ORGANISATION OF ITS KIND IN THE WORLD**

## REPLACEMENT REBUILT TV TUBES

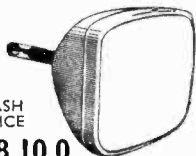

CASH  
PRICE  
**£8.10.0**

**£2**  
allowed  
on your  
old tube

OR yours for initial payment of 8/6, balance at 8/6 a week for 19 weeks. 12 months full guarantee. All sizes. Completely rebuilt gun assembly, new cathode, heaters, etc., giving the high standard required for long picture life, quality and value. Carr. & Ins. 15/6.

## EXTENSION SPEAKERS 19/9

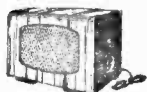

This superbly finished, polished oak cabinet fitted with 8" P.M. speaker of the highest quality, will look and sound ideal in any part of your home. Switch and flex included. Ready for immediate use. Ins. & Carr. 3/9.

Elliptical Speakers 19/6  
7 x 4in. or 9½ x 4½in.  
Post and Packing on each, 2/9.

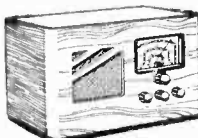

## HOME RADIO

A.C. or **79/6**  
Universal mains.  
Five valve octal superhet.  
3 waveband receiver.  
Attractive polished cabinet.

Dimensions: 9½ x 18½ x 11½in. Carr. & Ins. 4/6.

## B.S.R. MONARCH U.A.8 4-SPEED AUTOCHANGER

**£6/19/6**  
OR  
TERMS

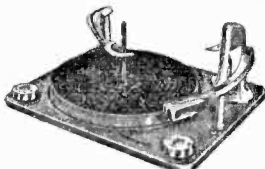

4-speed autochanger. Incorporating auto and manual control complete with turn-over crystal P.U. and Sapphire stylus. A.C. P. & Ins. 5/6 or initial payment 8/1 plus P. & Ins. and 19 weekly payments of 6/11.

T. U. 9. B.S.R. 4-speed single player **£4.9.6**  
Collaro Conquest 4-speed Autochanger **£6.19.6**  
Collaro Conquest Stereo Autochanger **9 gns.**  
P. & P. on all above 5/6.

Portable Amplifier Mk. D2, 4 wts. 2 control **79/6**  
Portable Amplifier Mk. D3, 4 wts. 3 control **89/6**  
Post and Packing on each, 3/6.

## RECORD PLAYER CABINET



**79/9**  
CASH  
OR  
**5/4**  
INITIAL  
PAYMENT

R.P.8.

Balance at 3/11 for 19 weeks. This contemporary cabinet of famous manufacture in two-tone grey rexine is ideal for the modern home. Added attraction is the cream plastic speaker fret. Press button lid; lock. Fittings for screw-in legs. Internal measurements 14½ x 18 x 8½in. deep. Takes a Garrard 121 Mk. 2; or B.S.R. U.A.12; 9½x4½ Elliptical speaker; Mk. 2 portable amplifier. Carr. and Ins. 5/6.

## DUKE & CO.

(Dept. E.5), 621/3 Romford Road, Manor Park, E.12  
Tel.: JLF 6001/3

(SEND FOR A FREE CATALOGUE)  
TERMS:—NO DEPOSIT—INTEREST FREE—20 OR 36 WEEKS TO PAY

## VIDIO 'REBUILDS' COST LESS—BECAUSE THEY'RE BETTER!

**TOP QUALITY  
and NEW GUN UNITS**

'NEW ALUMINIA'— a special service

Right up to Vidio-high standards, all types of re-screened and aluminised tubes are available now— immediate free delivery.

**ALL TUBES  
GUARANTEED FOR ONE YEAR**

Get full details NOW from

## VIDIO

Replacements Ltd.

HALES STREET  
DEPTFORD HIGH STREET  
LONDON, S.E.8

Tel.: TID 4506



## IS YOUR TV TUBE DIMMING? YOU CAN RESTORE BRIGHTNESS AND PICTURE QUALITY

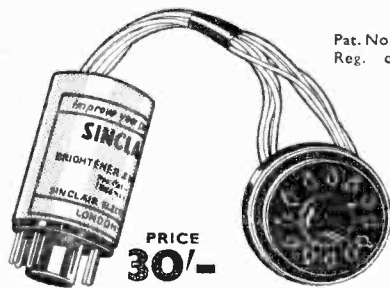

Pat. No. B36161  
Reg. design.

PRICE  
**30/-**

plus 2/6 P. & P.

Just plug in! No technical knowledge required.

The Sinclair Unit restores low emission on all sets operating off A.C. mains.

**IMPORTANT.** State make and model No. of set and tube in block capitals, please. If not satisfied money refunded if returned within 7 days.

**REBUILD TUBES ALSO AVAILABLE**

12 months unconditional guarantee  
12" **£5.0.0** 14" **£5.10.0** 17" **£7.0.0**  
carriage and insurance 12/6 extra

## SINCLAIR ELECTRONICS

33 BERWICK STREET, LONDON, W.1.

Terms: C.W.O. C.O.D.

Phone: REGent 5520

# TUBES

DIRECT FROM OUR FACTORY.  
New low prices. New top quality guns.  
ALL GUARANTEED

# 13 CHANNEL TV's

TABLE MODELS, FAMOUS MAKERS. Complete with all valves and tubes. These sets are unequalled in value due to huge purchase direct from source. They are untested and are not guaranteed to be in working order. Carr. Free.

AMAZINGLY POPULAR-IDEAL SECOND SETS

12" - £3.19.

14" - £7.10.

17" - £12.10.

12" 5 CHANNEL TV's 45/-

14" 5 CHANNEL TV's 85/-

Carriage and Insurance 12/6	
CRM92, MW22-7, MW22-14, MW22-14C, MW22-17, MW22-18	£2
12KPA, 12K, C12B, CRM121, CRM121A, CRM121B, CRM122, CRM123, MW31-14C, MW31-16, MW31-18, MW31-74	£2-10
141K, 7201A, C14FM, CRM141, CRM142, CRM143, MW36-24, MW36-24	£3-5
17ASP4, 171K, AW38/21, C17FM, CRM171, CRM172, MW43-64, MW43-69	£3-15
7401A, AW43-80, C14BM, C17BM, CRM151, CRM152A, CRM182B, CRM153, CRM173, MW43-80, MW41-1	£3-15
AW53-80, CRM212, MW53-20, MW53-30	£4-15

6 MONTHS REVUCUMED	12 MONTHS REGUNNED	12 MONTHS NEW TYPES
		MW31/74
	£4-10	£4-10
	£5-5	MW36/24
	£5-15	£7-15
	£6-15	MW43/64
		£8-10

NEW 108K (EQUIV.) TUBES SPECIAL OFFER: 39/-  
PLEASE NOTE: Many other types not listed available. S.A.E. enquiries

B.S.R. MONARDECK TAPE DECKS £9.10  
12in. TV's 5 channel table models including speaker, line trans., cabinet. Top makes requiring only valves and tube to complete, your choice if available (carr. 4/-). (Or £3 per dozen carr. free)

14in. TV's (carr. 4/-) 15/-

100 CONDENSERS 10/-  
A must for your spare box. A well-balanced assortment of miniature, silver mica and ceramic condensers. 3-10,000 PF. List value over £5.

100 RESISTORS: assortment 7/-  
1/2 watt

W.A. FOCUS MAGNETS  
Standard type, focus and centring controls, with mount unused, 9/8. Ditto, latest double magnet type, 12/6. ION TRAPS, 3/6

CO-AX standard and low loss, 25 yds, 12/6. 50 yds, 22/6. 100 yds, 42/6.

Co-ax. Plus 1/3. Wall coated boxes, 3/6

VALVES ALL GUARANTEED 3 MONTHS

PL81 SOILED AMAZING 4/6  
VALUE AT ONLY

EY51 SHORT ENDS 4/6 U25 SHORT ENDS 8/-

B.S.R. UAS AUTOCHANGERS £8.15  
TRANSISTORS: RED 4/6  
I.F., L.F. and Output up to 800 kc/s. (48-dizen). WHITE SPOT. R.F. and L.F. 2.5 Mc/s, 6/6 (89/- per dozen). XA103, 15/-; XA104 12/4; XB104 10/-; GET15 25/-

DIODES General purpose, famous make 9c. 8/- doz. GXE44 type, 3/9.

RECTIFIERS:  
12 volt 3-4 amps, 9/8. (Carr. 1/-) 25 per doz. 250 v. 80 m.a., 6/-, RM1, 6/6; RM2, 8/-; RM3, 9/-; RM3, 15/6; RM5, 21/-; 14A86, 17/-; 14A97, 23/-; 14A100, 25/-; 16RC1-1-16, 1/9; 18RA1, 1-16, 1/9; 18RD2-2-8, 1/9; 14BA1-2-8-2, 17/-; 14BA1-2-8-3, 20/-

TURRET TUNERS  
38 Mc. I.F. Standard Famous Make with coils listed. 27. Complete with PCF80 and PC84 valves, boxed (carr. 3/-). Ditto complete except for 1 oscillator coil, 29/-.

Ditto 16 Mc. I.F. complete all coils, 55/-.

EXTERNAL I.T.V. CONVERTERS WITH INTERNAL POWER PACK. Finished in hammered gold. Very compact. Trimming controls. Gain and Trimming controls. Listed 27/6. Carr. 2/6. £3/10/-

at £7.7.0. Our Price, carr. 2/6. £3/10/-

COLLARD CONQUEST CHANGERS £6.7.6  
PM SPEAKERS Standard 3 ohms, performance guaranteed.

8in. 8/- 5in. 11/- 10in. 13/-  
6in. 7X4

TV PROJECTION UNITS  
Complete Standard Philips optical units with Mullard MW6-2 projection tube £3/10/- (untested) at a fraction of cost.

LATEST COLLARD STUDIO TAPE TRANSCRIBER. Three motors, three speed, 11, 31, 74 i.p.s., takes tin. spools, super £13/15/- quality push button controls.

CONNECTING WIRE  
25 FT. P.V.C. Insul., excellent 1/-  
(5 coils, diff. colours, 4/6)

CRTs ECR30 (VCR139A), 15/- 5FP7, 12/6. ECR35 (VCR138), 9/- VCR97, 12/6.

B9A Ceramic super valveholders, (6/6 doz., 12/- 2 doz.) 8d.

BBC/ITA Aerials, famous make for high signal areas. 9/6

Plugs into set, var. attenuator, listed 27/6

14in. Table cabinets, mask glass 12/6

front fret (carr. 4/-).

# VALVES BY RETURN OF POST

10% DISCOUNT SPECIAL OFFER TO PURCHASERS of any SIX VALVES marked in black type (15% in dozen). Post: 1 valve, 6d.; 2-11, 1/-.

NEW LOW PRICES GUARANTEED 3 MONTHS

FREE TRANSIT INSURANCE. All valves are new or fully guaranteed ex-Government or ex-union origin. Satisfaction or Money Back Guarantee on goods if returned unused within 14 days.

024	5/6	6AT6	7/6	6X8GT	6/6	6X8GT	6/6	12K7GT	6/6	50C5	9/6	DF33	9/9	EC081	5/9	EL91	4/9	7B8	15/-	SU210A	4/6	UCH81	8/6
1A9GT	5/6	6AU6	7/9	6X7	5/9	7A7	10/6	12K8GT	11/6	50C6DG	11/6	DF91	4/6	EC082	5/9	EM34	8/6	EM38	18/-	TM1	7/6	UC182	11/3
1A7GT	5/6	6B7	9/8	6X7G	2/9	7B5	12/6	12K9GT	5/6	50D9	9/6	DF96	7/9	EC083	7/6	EM90	9/6	EM92	10/6	TH30C	12/6	UC183	13/6
1C9T	9/6	6B9G	3/6	6K8GT	5/4	7B8	9/8	12K12GT	6/4	53K10	10/6	DH63	6/9	EC084	8/9	EM91	9/3	P41	4/6	U14	8/4	UF41	8/6
1D7	9/6	6BA6	6/6	6K8G	5/6	7B7	7/3	12K13GT	5/6	54K10	9/9	DH78	5/9	EC085	8/3	EM84	5/9	P81	2/3	U18	8/4	UF42	6/9
1D6	9/6	6BE6	6/6	6K8S	10/4	7C5	7/9	12K17K	5/6	61S1T	11/4	DH77	7/6	EC086	9/9	EM85	10/6	PABC8011	1/2	U22	8/9	UF80	9/6
1HG5T	9/6	6BG6G	12/6	6K82E	7/6	7C6	7/3	22SN7GT	8/8	75E	8/6	DK32	11/9	EC087	9/6	EN31	16/-	PX24	7/6	U24	14/6	UF81	9/6
1L4	3/6	6B16	6/4	6L1	12/6	7D7	9/9	12T4	9/6	77	6/8	DK41	6/6	EC088	14/4	EX31	11/6	FR08	9/3	U25	13/6	UF86	14/6
1L15	3/6	6B36	6/4	6L6	9/6	7H7	7/8	1487	14/9	78	6/8	DK92	8/6	EC089	5/6	EX35	7/6	SMALL	8/6	PCC83	19/6	UF89	7/6
1LN5	4/6	6BR7	9/3	6L6G	7/6	7K7	8/6	19AQ5	7/6	80	6/8	DK96	7/9	EC090	8/6	EX36	8/6	PCC89	13/9	U31	7/8	UL41	7/6
1N6GT	9/6	6BW6	7/9	6L7	9/4	7R7	10/6	19B6G	6/15	83	9/8	DL33	8/9	EC091	8/3	EX35	8/6	PCC80	7/8	U33	13/6	UL44	12/6
1R5	6/6	6BW7	6/6	6L7G	7/6	787	8/6	20D1	9/6	90AV	4/6	DL35	8/9	EC092	7/6	EX40	6/8	PCC82	7/6	U35	8/9	UL46	9/6
184	9/6	6BX6	5/3	6L18	9/4	797	7/9	20P2	9/6	117Z	10/6	DL82	9/6	EC093	10/6	EX41	7/8	PCL82	8/6	U37	25/6	UL48	7/6
185	9/6	6C4	9/6	6L19	12/6	7Y4	7/6	20L1	13/6	185BT	16/6	DL91	8/9	EC094	13/6	EX42	6/8	PCC83	11/6	U43	8/9	UM80	9/6
1T4	4/6	6C5	5/6	6L3	6/6	7Z4	7/6	20P1	11/6	723A	29/6	DL92	6/6	EP22	12/6	EX21	7/6	PCL84	8/9	U50	6/6	U56	12/6
2D21	4/6	6C6	4/6	6L12	7/6	8Z3	3/6	20P3	12/6	807A	5/4	DL94	7/6	EP36	3/3	GT1C	7/6	PEN25	4/6	U52	5/6	U57	9/6
3A4	5/6	6C9	9/6	6L1D	20/6	8H6	10/6	20P4	13/6	807E	3/9	DL96	5/9	EC095	7/6	EX40	6/8	PCC82	7/6	U55	8/9	U58	18/6
3Q4	7/3	6CD6G	18/6	6N7	6/8	10C2	13/6	20P5	12/6	808	15/6	EA50	9d.	EP40	13/6	GT24	12/6	PEN48	5/3	U78	5/6	UY21	11/6
3Q5GT	9/6	6CH6	9/3	6P1	14/4	10C14	9/4	25A6G	8/4	955	3/9	EA8C80	7/8	EP41	8/6	GT27	10/6	PCL33	9/6	U91	9/6	UY21	11/6
384	6/6	6D1	9d.	6P25	9/4	10F1	6/9	25L6G	6/9	956	2/9	EA8C91	4/9	EP42	7/6	HABC80	9/6	PL36	11/6	U281	9/6	UY41	6/6
3V4	7/6	6D2	9/6	6P28	12/6	10F19	10/3	25L6GT	9/6	2050	3/9	EA442	8/6	EP50-BR	2/4	HLA1D	9/6	PL38	14/6	U282	15/6	UY42	6/6
3R4G	9/6	6D3	12/6	6P27G	9/6	10L14	9/6	25Y9	9/6	5763	10/6	EB34	1/6	EP50-USA	4/6	HVZ9	7/6	PL41	9/6	U301	9/6	VR150/30	6/6
0F4G	5/6	6D6	4/6	6P7GT	9/6	10L13	9/6	25Z4G	7/6	9001	4/6	EB41	7/6	EP51	3/6	KL55	7/9	PL32	11/6	U309	12/6		5/6
5Y4G	9/6	6E1	5/6	6P7A	7/6	10L1D12	9/6	25Z5	8/4	9003	4/6	EB11	3/9	EP54	3/3	KT32	6/9	PL33	7/6	U329	12/6	W61M	11/6
5Y3G	6/6	6F0G	6/6	6P8A7	5/9	10P113	9/6	2526	8/4	ATP4	2/9	EB23	9/6	EP80	5/3	KT33C	6/9	PL34	11/6	U339	11/6	W76	6/6
5Y3GT	6/6	6F6M	7/6	6SG7	4/9	10P14	9/6	2878	1/6	AZ31	9/6	EB33	5/6	EP85	7/6	KT36	9/6	PY32	18/6	U403	9/6	W77	4/9
5Z4G	6/6	6F12	3/6	6SH7	4/6	10P18	9/6	30C1	7/6	B38	8/6	EB41	8/6	EP86	10/3	KT44	9/6	PY81	9/6	U404	6/6	W81	5/9
6AT	10/6	6F14	5/6	6S17	5/4	12A6	4/9	30P5	7/6	B65	7/6	EB48	7/9	EP89	8/6	KT45	8/6	PY32	10/6	U401	17/6	X61M	12/6
6A8G	9/6	6F15	9/6	6SL7GT	6/4	12A8H	9/9	30L1	7/9	CB13L	21/6	EBF80	6/6	EP91	3/6	KT61	9/6	PY80	7/6	U408	8/9	X63	9/6
6A8GT	13/6	6F16	8/6	6SN7GT	4/9	12AT6	9/9	30P4	12/6	CL33	13/6	EB121	14/6	EP95	6/8	KT66	12/6	PY32	12/6	U401	8/6	X65	11/6
6AB8	8/3	6F23	6/9	6S87	5/6	12AT7	5/9	30P12	8/6	CY31	9/9	EB151	21/6	EP32	7/6	KT81	14/6	PY82	8/6	U401	8/6	X78	14/6
6AC7	4/3	6H6	4/3	6S13	4/3	12A7T	6/6	30P16	7/9	D08	1/6	EC092	3/9	EP92	4/6	KTW41	5/6	PY20	12/6	U401	10/6	X78	14/6
6AG5	4/3	6H3	4/3	6I4GT	10/6	12AX7	7/6	37-CL11	10/6	D77	3/9	EC093	3/6	EL33	9/6	KTW63	4/9	R19	12/6	U401	8/6	X79	16/6
6AG7	8/6	6J5G	2/9	6J5G	6/6	12BA6	8/6	35L6GT	9/4	D152	6/6	EC091	4/6	EL35	11/6	KTW63	5/6	R19	12/6	U401	8/6	X78	14/6
6AK5	6/9	6J5GT	3/9	6V6GT	6/6	12B6E	6/6	12B6E	6/6	DA30	12/6	EC091	9/6	EL37	11/6	L63	2/9	P52	9/6	U404	14/6	X88	8/3
6AL5	3/9	6J6	4/6	6V6GT	6/6	12BH7	14/6	35Z4GT	5/6	DA90	2/6	EC092	4/6	EL38	12/6	ML152	7/6	P52	9/6	U401	8/6	X88	8/3
6AM5	4/6	6J7	3/9	6C32	8/9	12C8	8/6	35Z6GT	3/6	DAC32	9/9	EC093	4/9	EL41	8/6	ML219	17/6	SP41	2/6	U401	8/6	X78	14/6
6AM6	3/6	6J7G	5/6	6X4	5/6	12E1	13/6	42	7/6	DAF91	5/3	EC094	9/6	EL42	4/6	MU14	3/4	SP61	1/6	U401	14/6	X152	5/3
6AQ5	6/6	6J7GT	7/9	6X5G	5/6	12E1GT	3/6	43	7/6	DAF96	7/9	EC095	6/9	EL54	7/6	N37	11/4	SP25	2/6	U402	14/6	X79	16/6

Post: 2 lbs. 1/6 4 lbs. 2/- 7 lbs. 2/9, 15 lbs. 3/6 etc. No C.O.D. ALL ITEMS LESS 5% & POST FREE IN DOZENS. (Callers always welcome). LIST OF 1000 SNIPS 6d.

TECHNICAL TRADING CO. P.O. BOX 21 (W) 350-352 FRATTON ROAD, PORTSMOUTH.

## BRAND NEW AM/FM (V.H.F.) CHASSIS AT £13.68. (P. & P. 10/-)

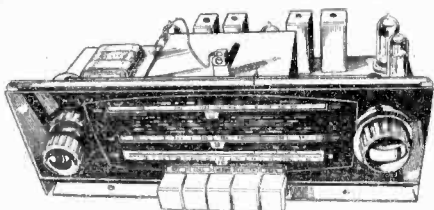

Why buy a F.M. Tuner at the same price?  
Tapped input 220-225 v. and 226-230 v. A.C. ONLY.  
Chassis size 15 x 6 1/2 x 5 1/2 in. high. New manufacture.  
Dial 1 1/4 x 4 in. in gold and black.  
Pick-up. Extension Speaker. Ae. E. and Dipole sockets. Five "piano" push buttons—OFF, L.W., M.W., F.M. and Gram. Aligned and tested.  
With all valves & O.P. Transformer. Tone-control fitted.  
Covers 1,000-1,900 M.; 200-500 M.; 86-99 Mc/s.  
Valves EZ80 rect., ECH81, EF89, EABC80, EL84, ECC85. Speaker & Cabinet to fit chassis, 47/6.  
10 x 6 in. ELLIPTICAL SPEAKER. 20/-.

**TERMS:**—(Chassis) £4.16.8 down—10/- carr.—and 6 Monthly Payments of 30/-, or with Cabinet & Speaker £5.9.2 down and 7 Monthly Payments of 32/-.

We are specialists in ITA Converters. Our converters give direct switching ITA to BBC, metal rectifier, co-axial plug. Can be fitted in 5-10 mins., and need no alteration to your set; ALL AREAS. ALL SETS. ALL CHANNELS. 12 months' guarantee (3 months on valves).

### "READY TO USE" ITA CONVERTER

Separate gain controls. Valves PCF80 and PC84. Switch positions ITA (1)—ITA (2)—BBC. Bakelite moulded cabinet 8 1/2 x 4 x 6 in. £5.5.0. P. & P. 3/-.



**3-VALVE AMPLIFIER (INCL. RECT.)** Capable of giving 6 watts. Mains and output transformers. Valves ECC81, EL84 and Rect. 3 Controls, volume, bass and treble. On/Off switch. Fully guaranteed. Chassis size 6 1/2 x 3 x 2 1/2 in.; with 7 x 4 in. elliptical speaker or 6 1/2 in. round (Goodmans); state which.

**Only 67/- (P. & P.)**

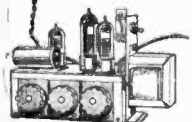

### STUPENDOUS OFFER! 13-CHANNEL TUNER

I.F. 34-38 Mc/s complete with valves PCF80 and PC84. Removed from chassis but in working order.



**15/-** (2/6 P. & P.). Knobs 2/6 extra. Some tuners less valves 7/6.

### ITA TABLE TOP AERIAL.

An ITA table top aerial with amazing performance. The Wolsey HI-Q at 19/6 (2/6 post). Gives good reception up to 20 miles, and has cross-over unit in base with socket for BBC aerial. Same model but very slightly tarnished for **ONLY 12/6** (2/6 post).



**PERSPEX UNSCRATCHED.** (Post 2/- each or 6 post free.) 12 1/2 x 9 1/2 x 1/2 in. clear, 4/6; 14 1/2 x 11 x 1/2 in. clear, 5/-; 15 x 12 x 1/2 in. tinted, 6/-; (Also 15 x 12 in. slightly scratched at 3/-.)

**AUTOMATIC RECORD CHANGERS. COLLARO CONQUEST** with manual play also. Turnover crystal pick-up. 4-speed, A.C. mains 200-250 v., see illus.

**£7.10.0** (P. & P.)

B.S.R. 4-speed U.A.S. auto-changer **£8.15.0** (5/- carriage).

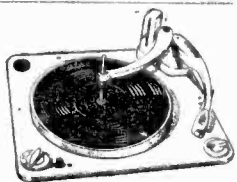

For the last 50 ITA Converters of this type (Brand New and Fully Guaranteed) we will accept the "Below Cost" figure of **ONLY (3/- P. & P.)** Reduced from £4.7.6.  
Two valves ECC81—grey hammer finish—switch positions OFF, ITA, BBC. Own Power supply. **BUY IT NOW.**

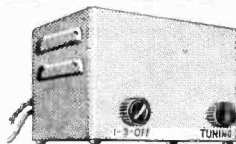

**60/-** (3/- P. & P.)

**THE BRAYHEAD TURRET TUNER.** £7.7.0 post free. Complete with booklet and fitting instructions. State set and model No. when ordering.  
Converts your 5-channel BBC only set to receive ITA as well.

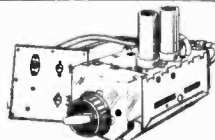

**ITA AERIALS** clipping to existing mast 1-2 in. dia. 3-element, 22/-; 5-el. 30/-; 9-el. 50/-; Loft mounting, 3-el. 20/-; 5-el. 26/-; Combined single BBC and 5-el. ITA, 75/- with chimney-lashings; Co-axial cable semi-air-spaced, 7d. yd. or 20 yds., 11/-; Aerial prices carr. paid. Postage on cable 1/-.

**50 SILVERED MICA AND CERAMIC CONDENSERS. 10/- 50 RESISTORS. 5/- ALL NEW.**

**NEW WAXED TUBULARS.** 350 v. or above, 3 of each. .001, .002, .005, .01, .02, .05, .1 mF. Total 21 for 4/6, post paid.

**NEW ITA AND BBC TUNER.** By well-known manufacturer for superhet TVs with 35-38 Mc/s I.F. For all areas; covers all 13 channels. Switch gives BBC and two ITA selections. Suits G.B.C. sets BT4543, 4544, 5146, 5147, 5593, 5642 and 6641 without alteration. Easily adapted as aerial converter, and instructions can be provided free. Has ITA and BBC co-axial sockets and separate gain controls.  
**WITH VALVES PCF80 and PC84. 22/6** (P. & P. 3/-). Some without valves at only 12/6 (P. & P. 3/-).



**GRAMOPHONE AMPLIFIER** with 5 in. SPEAKER. On Fabric-covered Baffle 12 1/2 x 5". Mains and Output Transformers. Metal Rectifier. ECL82 Valve. Tone and Volume Controls. On/Off switch. Plenty of Volume. Fully Guaranteed. Two Knobs supplied. Ready to play. Useful for Stereo.

**ONLY 57/-, post 3/-**



### LISTEN WITHOUT INTERFERENCE

Fully built V.H.F./F.M. set. Wired, aligned and tested. 6 Mullard valves with mains transformer, 80-98 Mc/s. **ONLY £8.8.0** (4/- carr.). Cheap room dipole 10/- 300 ohm twin feeder. 6d. yd. All with 12 Months guarantee.

Delivery by return. C.O.D. 2/- extra. Terms: Cash with order or one-third down and balance plus 7/6 (up to £7.10.0) in four equal monthly payments. Balance over £7.10.0 add 1/- in £1 and pay in not more than 6 monthly payments. See special terms for A.M.-F.M. chassis. All new goods unless stated. Send 6d. for 16-page catalogue.

**GLADSTONE RADIO**

58A HIGH STREET, CAMBERLEY, SURREY.

Tel. 22791

(Camberley closed Sats.)





# Practical Television

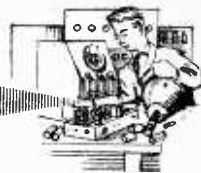

## & TELEVISION TIMES

Vol. 10 No. 116

EVERY MONTH

MAY, 1960

Editorial and Advertisement Offices:  
**PRACTICAL TELEVISION**  
George Newnes, Ltd., Tower House,  
Southampton Street, Strand, W.C.2.  
© George Newnes Ltd., 1960.

Phone: Temple Bar 4363  
Telegrams: Newnes, Rand, London.  
Registered at the G.P.O. for trans-  
mission by Canadian Magazine Post.

### SUBSCRIPTION RATES

including postage for one year

Inland - - £1.2.0 per annum  
Abroad - - £1.0.6 per annum  
Canada - - 19s. per annum

### CONTENTS:

	Page
Editorial . . . . .	395
Frame Blocking Oscillator . . . . .	396
Servicing TV Receivers . . . . .	399
A Universal Valve Tester . . . . .	401
Telenews . . . . .	404
Power Supply Circuits . . . . .	406
TV Turntable . . . . .	408
Aerial Feeder Matching . . . . .	409
I.F. Wobbulator . . . . .	413
Printed Aerial Filter Unit . . . . .	416
A Remote Controller . . . . .	420
Measuring Low Resistance . . . . .	423
Underneath the Dipole . . . . .	427
Trade News . . . . .	431
Letters to the Editor . . . . .	435
Your Problems Solved . . . . .	436

The Editor will be pleased to consider articles of a practical nature suitable for publication in "Practical Television". Such articles should be written on one side of the paper only, and should contain the name and address of the sender. Whilst the Editor does not hold himself responsible for the manuscripts, every effort will be made to return them if a stamped and addressed envelope is enclosed. All correspondence intended for the Editor should be addressed to The Editor, "Practical Television," George Newnes, Ltd., Tower House, Southampton Street, Strand, W.C.2.

Owing to the rapid progress in the design of radio and television apparatus and in our efforts to keep our readers in touch with the latest developments, we give no warranty that apparatus described in our columns is not the subject of letters patent.

Copyright in all drawings, photographs and articles published in "Practical Television" is specifically reserved throughout the countries signatory to the Bern Convention and the U.S.A. Reproduction in whole or in part of any of these are therefore expressly forbidden.

## Fringe Area Reception

SINCE television began, it has advanced steadily; new techniques have been evolved, new transmitting stations built and the service areas of the existing stations extended. Now nearly all of the British Isles is covered by television and no doubt within the near future the whole country will be able to receive at least one programme. The emphasis now therefore in the development of television as a means of entertainment is being laid upon increased coverage. It is not generally realised that even within the service areas of well-established transmitters there are locations where reception of programmes is difficult or impossible. The difficulties are of course more pronounced on Band III, where signals tend to be limited to a near-optical range, than on Band I. The remedy commonly suggested for improving or obtaining reception is the use of a multi-element aerial, or even two aerials mounted side by side. We receive many letters from readers who have been told that this is the only way to improve reception. The fact is that increasing the number of elements on the aerial may make reception more difficult; as the length of the aerial is increased, so reflection effects tend to become more prominent and, of course, the resulting array is very directional. Thus, the use of a five-element aerial may, depending on circumstances, give better results than the use of a ten-element type. By far the best advice which can be given to viewers living in fringe or "difficult" areas concerns the positioning of the aerial. Moving the aerial, by even a few feet, particularly on Band III can sometimes enable a signal to be received. In general, the aerial should be placed as high as possible, but during initial experiments it may be connected to a length of low-loss coaxial cable and moved around the house (and possibly even the garden) in search of a signal.

Eventually, when a signal is obtained, it may be too weak for perfect operation of the receiver and periodic tearing of the picture may be experienced. The picture, and possibly the sound may be "noisy" and of poor entertainment value. However, it may be possible to improve results by employing a pre-amplifier stage between the aerial and the receiver although if the signal-to-noise ratio is initially below a certain level, there may be no improvement by the addition. In many instances there may be a worthwhile improvement and therefore we have designed a two-band pre-amp which will be featured in our next issue. The unit uses a frame-grid double triode valve in a cascade circuit for low noise and high gain and, in many areas, will prove a valuable addition to existing receivers. The article will include complete constructional details of the pre-amp, together with full alignment data.

*Our next issue, dated June, will be published on May 20th*

# Frame Blocking Oscillator

## A COMPLETE PRACTICAL CIRCUIT

THE part of a receiver which embraces the sync separator and the frame timebase is undoubtedly of most interest to the constructor. The line section is rather too complicated, in view of the inclusion of the line output transformer.

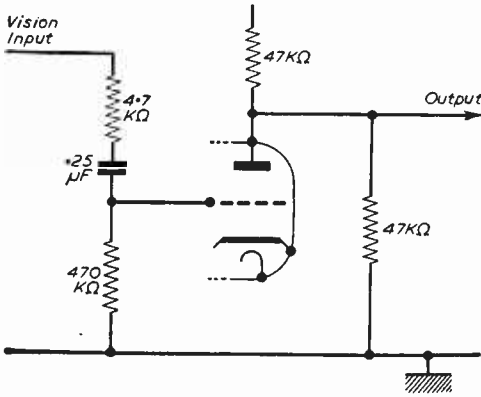

Fig. 1.—A triode sync separator.

The conventional sync separator is the saturated pentode, but it is possible to make use of a triode, which may be a separate valve, or one section of a triode-pentode, the other portion of which may be used as the frame output stage or the sound output stage. A circuit recommended by Mullard, and described in one of their Technical Communications publications is shown in Fig. 1 and this may be fed into flywheel synchronising circuits and timebases in the ordinary way.

Many experimenters prefer the multivibrator type of oscillator for their timebases, and whilst these do function fairly easily, they are subject to stray capacity effects, and it is possible to make up two circuits with identical values which will not function in the same manner, simply on account of the layout. On the other hand, the blocking oscillator is practically foolproof, provided that a suitable transformer is employed. This is the only difficulty and care should be taken to use a transformer which is designed for the type of blocking oscillator which is employed. The following description of a frame blocking oscillator is based on information contained in Volume 5, Number 42 of Mullard Technical Communications.

### The Blocking Oscillator

A conventional blocking oscillator for use as a frame sawtooth generator is shown in Fig. 2. The important features of this type of circuit are:

- (1) A transformer is required.
- (2) When the oscillator triggers, a large amplitude pulse is produced, across the transformer,

which might, in many cases complicate the design of the synchronising circuit.

(3) The peak current required from the valve when the oscillator triggers is several times greater than with a cathode-coupled multivibrator. A typical value of peak cathode current is between 100 and 200mA.

### Frame Oscillator Requirements

The function of the frame oscillator valve is to produce a sawtooth waveform of about 30V amplitude across a capacitor. The valve acts as a switch discharging the capacitor to produce the flyback, and is cut off during the scan allowing the capacitor to re-charge through a high resistance towards a high positive potential. The resulting sawtooth must be sufficiently linear to permit the design of a reasonably simple linearising network in conjunction with the frame output stage.

Equalising pulses are not used in the British 405-line television system, therefore the separated frame synchronising pulses may have different durations on odd and even frames. To prevent this difference affecting the oscillator conduction time, a fast oscillator flyback must be used; a typical value being about 200μs.

To obtain a sufficiently linear sawtooth it is necessary that the initial portion only of the exponential increase of potential across the charging capacitor be utilised. This requires a long time constant changing towards a high potential, a typical value for the capacitor being about 0.1μF.

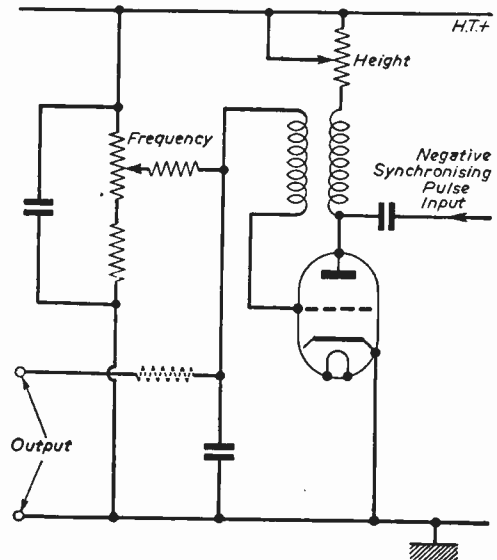

Fig. 2.—Conventional blocking oscillator.

**Design Considerations**

Assuming a value of  $0.1\mu\text{F}$  for the charge capacitor and an oscillator conduction time of  $200\mu\text{s}$ , the peak current required to produce a sawtooth of 30V amplitude is  $V.C./t$ , which equals 15mA.

Because the current pulse is not rectangular the peak current in the capacitor will be about twice

the final value will depend on the feedback circuit, a typical value being about 50mA.

In a blocking oscillator circuit the control grid of the valve is driven very positive (20 to 30V) to achieve this discharge current, and the resulting cathode current ( $i_g+i_a$ ) is much higher, because the grid and anode currents are comparable in value.

The output sawtooth waveform may be taken from the anode or the grid circuit. The advantage of utilising the grid circuit waveform is that the grid capacitor is discharged negatively and aims towards a positive potential. The aiming potential is thus effectively increased by the negative excursion which tends to improve the linearity of the waveform.

**Interaction of Controls**

An important consideration in the design of a frame timebase is the interaction of controls. Adjustment of the linearity controls, for example, changes the shape of the waveform fed back to the oscillator via the linearity network.

It might be expected that the use of the anode waveform would produce less interaction of the controls. In practice, however, the tight coupling between the grid and anode circuits through the transformer prevents any effective buffering action. A circuit technique often used to minimise interaction of controls, is to use a series buffer resistor placed between the oscillator and the output stage (shown dotted in Fig. 2). The amplitude of the drive waveform for such a circuit is much greater (typical value about 80V) due to the attenuation across the buffer resistor arising from the input impedance of the frame output stage. Since the required oscillator output is then much larger the peak valve currents will be correspondingly increased.

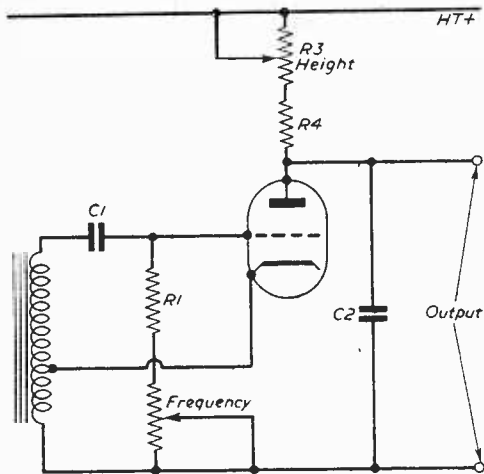

**Fig. 3.—Cathode-coupled blocking oscillator.**

this value. Additional current will be supplied during the flyback period, because a positive-going pulse is produced across the output transformer and fed back to the charge capacitor via the linearity network. The current required from the oscillator is therefore the sum of these currents, and

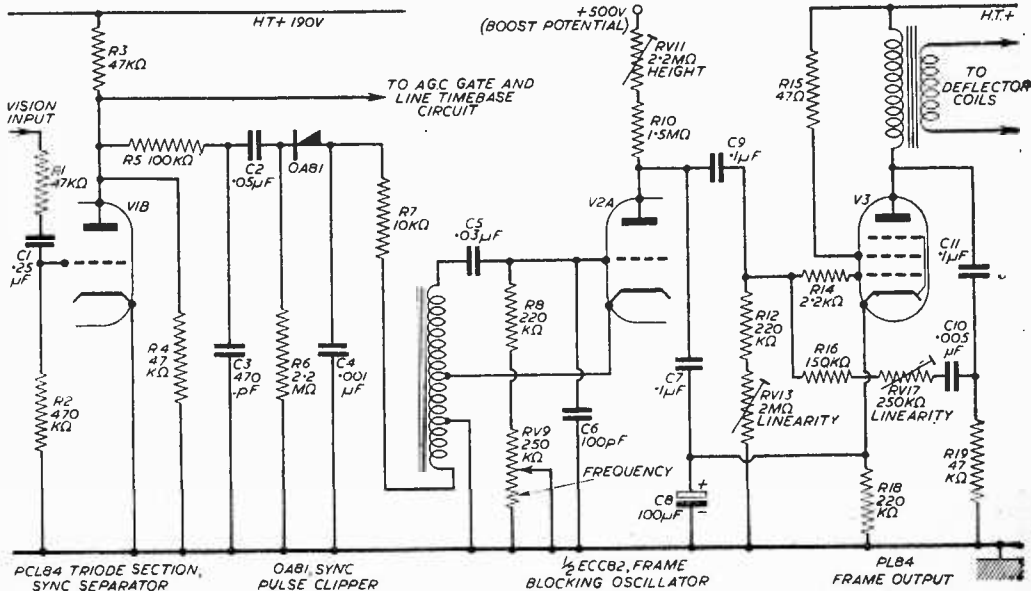

**Fig. 4.—Complete frame timebase.**

A further shortcoming of this circuit technique is the resulting high A.C. impedance at the control grid of the frame output valve and the possibility of hum pick-up.

### Cathode-Coupled Blocking Oscillator

As large values of peak cathode current shorten the useful valve life it is advantageous to reduce such currents to a minimum. At the same time the oscillator frequency should be reasonably independent of the other timebase controls. The output, which can be obtained from the free anode of a cathode-coupled blocking oscillator, enables the valve to provide the buffering action without attenuation of the output sawtooth.

The basic circuit of the cathode-coupled blocking oscillator is shown in Fig. 3, the operation being similar to a conventional anode-coupled circuit. The significant difference, apart from the isolation provided by the valve between the output circuit and the frequency determining components R1C1, is that a positive synchronising signal is required because no phase inversion is provided by the transformer. To synchronise the oscillator with a negative-going pulse, a separate winding or overwind must be provided.

### Circuit Description

A complete frame timebase circuit employing a cathode-coupled blocking oscillator is shown in Fig. 4 and the waveforms occurring in the circuit in Fig. 5. The operation is as follows:

The separated synchronising pulses from the anode of the synchronising pulse separator V1B (½PCL84) are integrated by R5C3. The integrated waveform is A.C. coupled to the self-biased diode (OA81) limiter. The integrated frame pulse causes the diode to conduct and the resulting current pulse, flowing through the transformer, triggers the oscillator. When the oscillator triggers, a pulse, produced across the synchronising winding of the transformer, is fed back to the diode. To reduce the overshoot amplitude, a filter network (R7C4) is interposed between the transformer and the diode.

The oscillator frequency is controlled by variation of the grid time constant (RV9). The output sawtooth, developed across the charge capacitor C7, is taken directly to the grid circuit of a conventional output stage. The boost potential is used as the aiming potential for the charge capacitor to improve the sawtooth linearity since

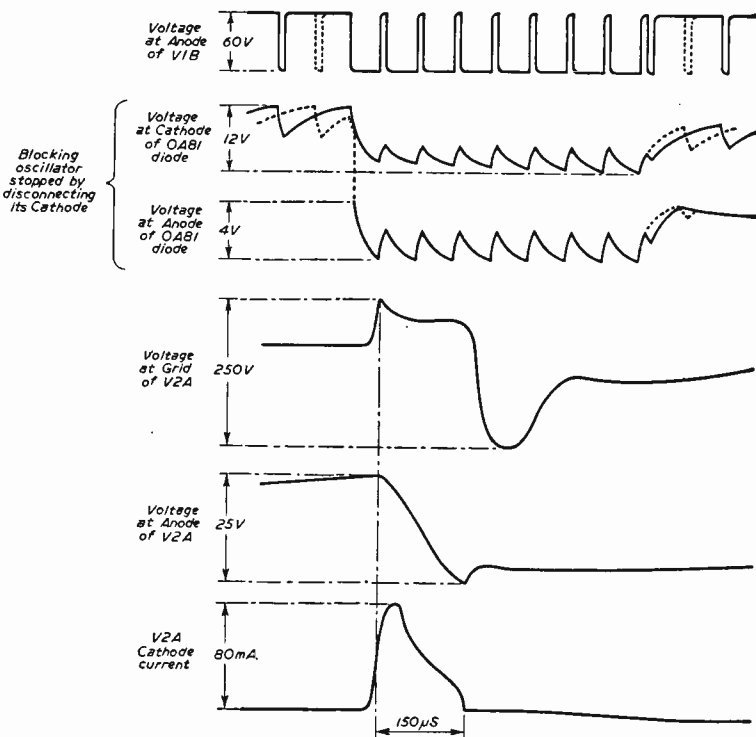

Fig. 5.—Waveforms for Fig. 3.

the mean anode potential of the triode is about 100V.

### Line Timebase Interference

In an experimental receiver line pulses picked up in the grid circuit tended to cause pairing of the scanning lines. The effect was removed by the addition of capacitor C6.

### Impulsive Noise

The stability of the frame synchronisation when the receiver was subjected to severe noise inputs from a controlled noise generator was very satisfactory. Only noise pulses occurring just in front of the frame synchronising pulses can affect the oscillator because at all other times the control grid is well below cutoff and the synchronising input is limited in amplitude.

### Transformer Specification

**Windings :** 4480 turns (start: grid) tapped at 2500 (cathode) and at 3880 (earth). Finish 4480 (sync).

**Wire:** 40s.w.g. enamelled - copper wire, scramble wound.

**Laminations :** 12 pairs interleaved E and I stampings No. 40, Silcor II as supplied by Magnetic and Electrical Alloys Ltd.

# Servicing Television Receivers

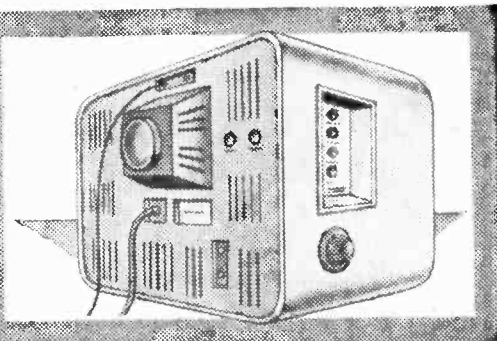

No. 55—THE PHILIPS 1115U, STELLA ST8314U, etc.

By L. Lawry-Johns

(Continued from page 346 of the April issue)

**T**HE previous article dealt with faults in the timebase sections of the above receivers and we now deal with other faults including those in the turret tuners which are fitted to some receivers.

### Hum Bars

Sometimes these receivers in common with many others have the symptom of "No picture, screen divided into black and white bars". The symptoms are often reported as lack of height, the raster being visible at the top or bottom half only. In fact, if the brilliance is advanced, the black portion will show up greyish, proving that the height is present and the raster severely shaded. Reversing the mains leads (or two pin plug if fitted) will reverse the area shaded, i.e., the black will now be at the top instead of at the bottom or vice versa. The immediate suspect is the vision detector EB91 (V9) and replacement will nearly always cure the condition. However, there are times when the picture is present but heavily shaded as above. This normally indicates heater-cathode leakage in an EF80 vision circuit valve but other symptoms will almost certainly present themselves since the bias (cathode) resistor or resistors will then be shunting the remainder of the heater chain depending upon the severity of the short and the value of the cathode resistor. For example, if V8 develops a direct heater-cathode short the 180Ω cathode resistor will shunt the heaters of V10, 9, 5 and the CRT. The resistor will overheat and the heaters of the above valves will dim considerably as the effective heater current will be approximately halved. Thus, the picture and sound will fade out, or will not come on at all. In the case of V7, the symptoms will depend upon the setting of the contrast control. With the control towards minimum gain (maximum resistance) the shunting effect on the other heaters will not be too severe and the symptoms will be a severely shaded picture (light and dark areas). As the contrast is advanced, the heaters of V8, 10, 9, 5 and the CRT become shunted and the picture will dim. Fortunately this is not a common fault but it does happen.

### No Vision Signals

If the sound is in order and the screen illuminates normally as the brilliance is advanced, with no

modulation present, check V7, 8, 9, 10 and voltage to pins 8 and 7 of each EF80 valve base. As far as V7 and V8 are concerned a voltage of about 160-180 may be accepted at each pin. The potential at pin 1 of V7 varies with contrast, 2.5V being normal. About 2V should be recorded at pin 1 of V8. Voltages of V10 with no signal applied are, pin 7—160 approximately, 8—135 J—2.5. A normal signal input will cause the following voltages to be obtained, pin 7—130 to 145, pin 8—100, approximately, pin 1—5, pin 2 (grid) about 3. All these voltages vary according to the signal input, when it is present, as determined by the sensitivity and contrast settings.

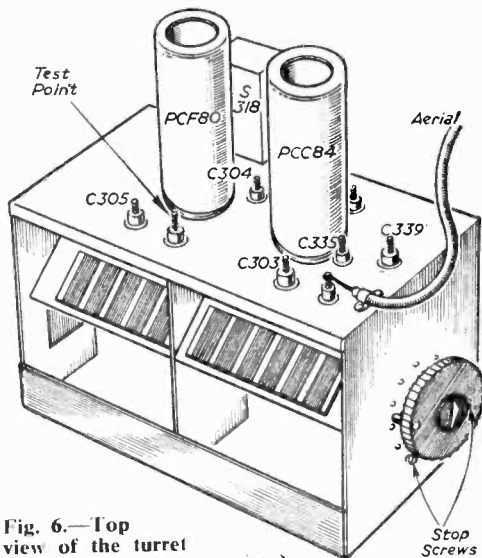

Fig. 6.—Top view of the turret tuner. (Note the stop screws.)

Where a voltage reading is very low or absent, check the feed resistor and decoupling capacitor and the valve itself.

### No Sound Signals (Picture Normal)

Advance the volume control. If no hum is present, see that the speaker leads are connected and check

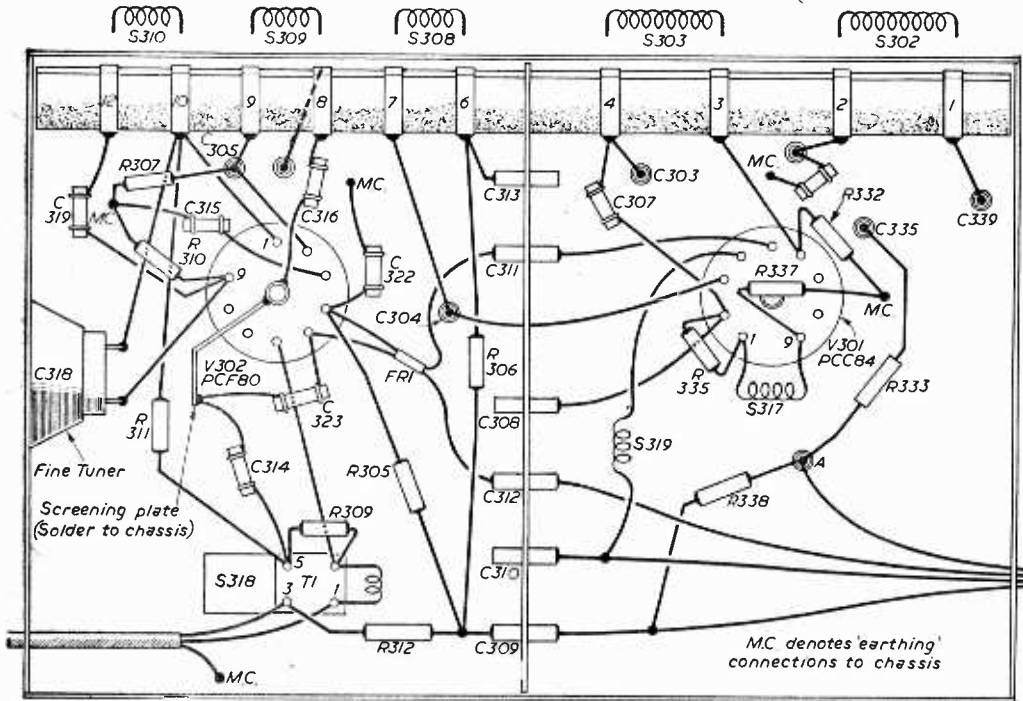

Fig. 7.—Underside of the turret tuner showing position of components.

PL82 (V6), sound output transformer, C31, R175. If hum is present but not affected by the volume control, check EC1.80 (V4) and its 220k anode resistor (R31) to pin 1. Distortion results as this goes high. If the volume does affect the hum level, check back to V5, V4 and V3, examining these valves and the base voltages. Valve V4 has two sections, a triode which functions as an audio amplifier and a pentode which functions as the second sound I.F. amplifier. Voltages to expect are V4, pin 1—48, pin 6, about 130, pin 8 117, pin 3, 3 approximately, V3, pin 7, 150, pin 8, 176.

**No Sound, No Vision Signals**

The raster is normal when brilliance is advanced. Check V1 and V2 valves having ensured that the aerial input is in order. Check the seating of the coil cans on the front right side, sensitivity control and valve base voltages: V1—pin 1, 2-6, pin 7, 130-175, pin 8, 165-180, V2—pin 7, 170, pin 8, 110.

**No Signals on Turret-Tuned Models**

Check PCC84 and PCF80 valves and examine resistors R306 and R312. If these resistors are charred, check C313 and C314. A short in the PCF80 can cause R312 to burn out but quite often the associated lead-through capacitor C313 breaks down causing R306 to overheat and burn out. A short in C314 (which is suspended in the wiring) will damage R312. Voltages to be expected are, PCC84—pin 1, 85-140, pin 2, 82-135, pin 3, 170-180, pin 7, 1-3—10, pin 8, as 7; pin 9, as 1; PCF80—pin 1, 55, pin 2, 2-2, pin 3, 120, pin 6, 165.

**Replacing Components in Tuner**

The position of all components must be maintained. In the case of C313 a replacement decoupling capacitor could be of the disc type soldered from spring tag 6 to the chassis point of C313. Disturbing other components will affect tuning since the circuit stray capacity will be altered and at the frequency employed this has a profound effect on the tuning.

**Stop Screws**

As supplied, 1446U and kindred models have a turret tuner but the switch has only three positions. When extra coils are to be added or the turret is required to be rotated the rear stop screws must be unscrewed—a flange on the turret is obstructed by the screw on either side to limit rotation. The purpose of this limitation is to enable only the loaded positions to be selected (one Band I, two Band II) thus avoiding confusion to the lay user who may be "lost" by the greater number of blank positions.

**Trimmers**

All trimmers are securely sealed and these seals must not be broken unless absolutely necessary. The trimmer threads are very coarse and unless properly sealed will quickly move. In addition the threads must have a good contact with chassis and this contact may not be so positive once the sealing is broken, resulting in variation in gain and sometimes complete loss of signals. **Note:** not all

(Continued on page 419)

# A Universal Valve Tester

CHECK HEATER TO CATHODE INSULATION AND EMISSION By J. Hillman

WITH this tester most valves can be tested for emission, for heater/cathode shorts and for leakages between any two pins. These latter tests are carried out with the valve heaters at normal temperature. Ten valve holders are used; namely British 5, 7 and 9 pin; Mazda and International octal; miniature 7, 8 and 9 pin; large glass 8 and 9 pin. In addition an adaptor can be used for testing any other type of valveholder not covered by this tester including CRT's. The H.T. voltages are applied to both anode and screen, and the emission is registered on the 30mA meter. A switch with six positions controls the H.T. voltage used and the current is limited by a fuse bulb of 40mA in the H.T. negative lead. The grid of the valve under test is normally returned to H.T. negative but on operating a switch a resistance is inserted in series with the grid lead and if grid current is flowing, then the meter reading will alter. The

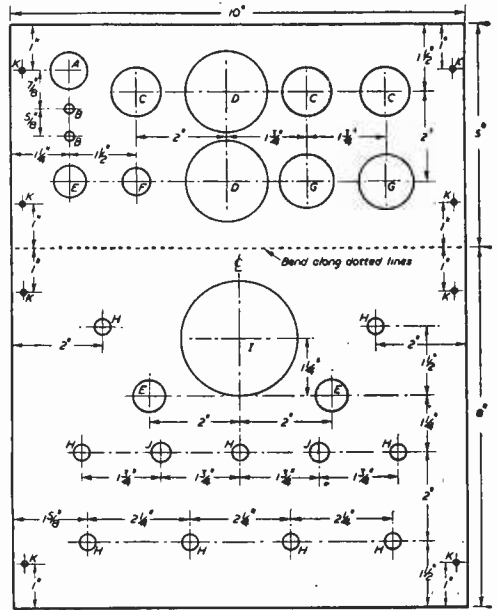

A- $\frac{3}{8}$ " B- $\frac{7}{32}$ " C- $\frac{1}{16}$ " D- $\frac{17}{8}$ " E- $\frac{1}{4}$ " F- $\frac{5}{8}$ " G- $\frac{1}{4}$ " H- $\frac{3}{8}$ " I- $\frac{25}{8}$ " J- $\frac{7}{16}$ " K- $\frac{1}{8}$ "  
**Fig. 1.—Drilling details of metal panel.**

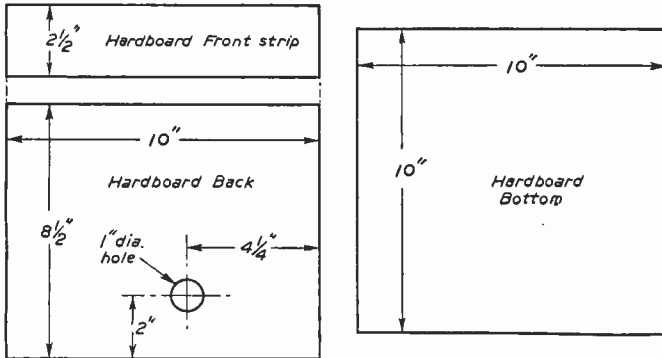

**Fig. 2.—Dimensions of the case.**

switch, the insulation of any two pins can be tested. This latter test can also be used to check continuity of heaters before proceeding to check emission.

It will be noted that a  $1\mu\text{F}$  paper condenser is put in parallel with the neon and this eliminates the slight glow caused by capacity of wiring. By using a large capacity, the time taken for it to charge up and discharge through the neon is long enough for all tests to be carried out. Incidentally, this charge and discharge can be used to clear

amount of this alteration will give an indication of the "softness" of the valve.

### Heaters

The heater voltages are selected by a 2-pole, 12-way switch and the voltages are 1, 2, 4, 5, 6, 9, 13, 15, 20, 24, 30 and although the highest voltage is only 30 this is quite sufficient to test 50V valves. It will be noticed that there is no switch for the grid connection to the pins and this is done by using a wander lead with two wander plugs—one going to the grid socket and the other going to one of the pins of the British 9-pin valveholder. The top cap socket is provided with a wander lead also, but with a crocodile clip on one end to enable it to be clipped on to the top cap or side cap of the valve under test. The leakage tests are carried out by means of a neon lamp in series with H.T. negative and the cathode switch. Thus, by using the anode switch in conjunction with the cathode

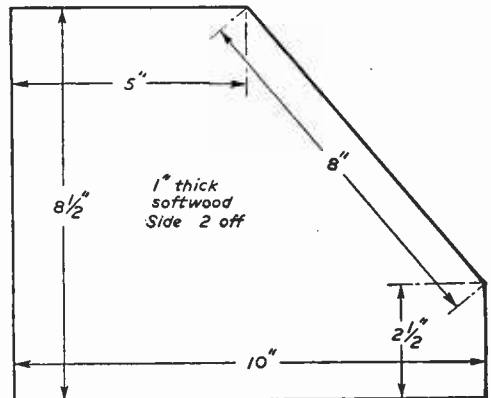

**Fig. 3.—Measurements of the sides.**

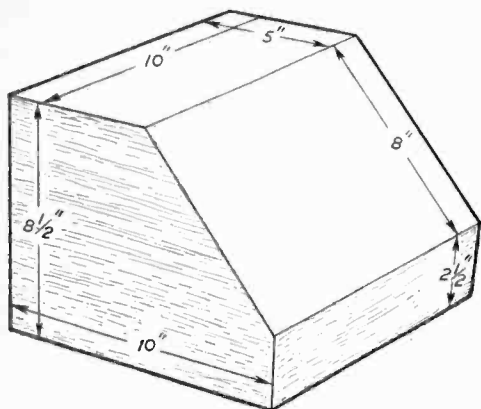

Fig. 4.—The completed case.

some insulation faults if left on for some time. The metal panel is earthed by a separate lead and is not connected to the H.T. negative in any way.

**Construction**

First mark out and cut a piece of aluminium 10in. x 13in. Then mark and centre-punch the holes as shown in Fig. 1. Each hole shown is designated by a letter giving the size of drill to use. The larger hole "I" may be punched out with a cold chisel or a series of holes drilled around and the hole finished off to size with a

file. Next, cut out the two sides as in Fig. 3 and bend the metal panel to fit the sides of 5in. and 8in. Having done this, paint the panel with crackle paint or enamel. When the paint is dry, screw the panel to the wooden sides with woodscrews and cut out the hardboard front strip Fig. 2, and glue and pin this to the 2 1/2in. front. To cover the join of metal and hardboard use a black PVC tape. The cabinet should now appear as Fig. 4.

The switches and meter and lampholders are now fitted to the front panel and the valve holders to the top panel. The mains transformer is mounted by screwing it to the inside of one of the wooden sides keeping it near the bottom and to the back. Wire up the valveholders first using coloured PVC wire as follows: pin 1-red; pin 2-yellow; pin 3-green; pin 4-purple; pin 5-black; pin 6-brown; pin 7-white; pin 8-orange; pin 9-pink; top cap-grey. Start with pin 1 of the miniature 9 pin valveholder

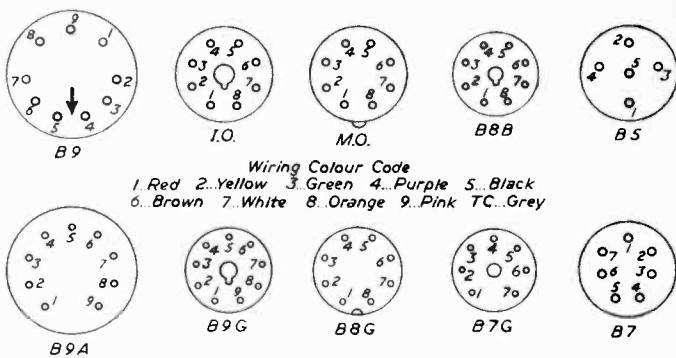

Fig. 6.—The valve bases and the wiring colour code.

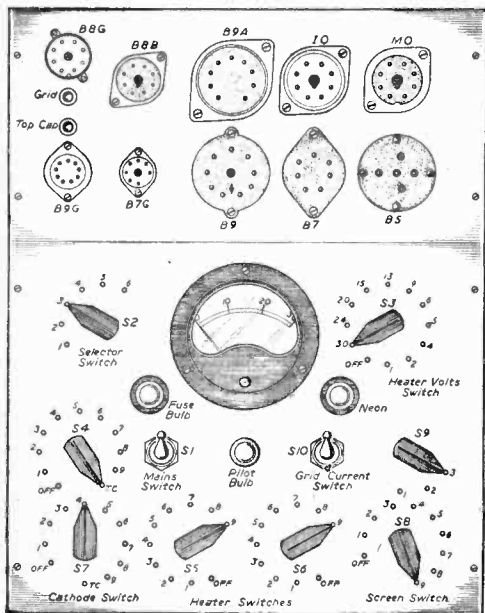

Fig. 5.—The front panel of the tester.

and continue to pin 1 of the 7 pin holder; pin 1 of the British 9 pin; pin 1 of the 7 pin; the 5 pin then across to pin 1 of the International Octal; on to the Mazda Octal; the large glass 9 pin; the large glass 8 pin; finishing at small glass 8 pin. Similarly with pins 2, 3, 4, 5. With pin 6, of course, the British 5 pin will be bypassed and the lead from pin 6 of the British 7 pin will go to pin 6 of the International Octal valveholder. With pin 7 the same holds true, but when pin 8 is wired up, the wire is taken from pin 8 of the small 9 pin past the 7 pin to the large British 9 pin then across to the Int. Octal on to the Mazda Octal; large glass 9 pin and the two 8 pins. With pin 9, the wires goes from small 9 pin to large 9 pin; large glass 9 pin and finally to the centre spigot of large glass 8 pin. Next measure up the length of wire needed to reach from the mains transformer to the heater voltage switch and remove the switch and wire it up out of the case using colour coded wires and twisting them into one large lead. This makes neater wiring and it is much easier to solder the switch out of the case.

Now wire up the anode, screen, cathode, and two heater switches starting with one contact on each switch and working through the contacts. Then wire up the tenth to the top cap socket. Leave one contact blank before the first contact on each switch. Next wire up the H.T. leads to the rectifier and meter and voltage switch. The metal rectifiers are supported by using a 4B.A. threaded rod and securing



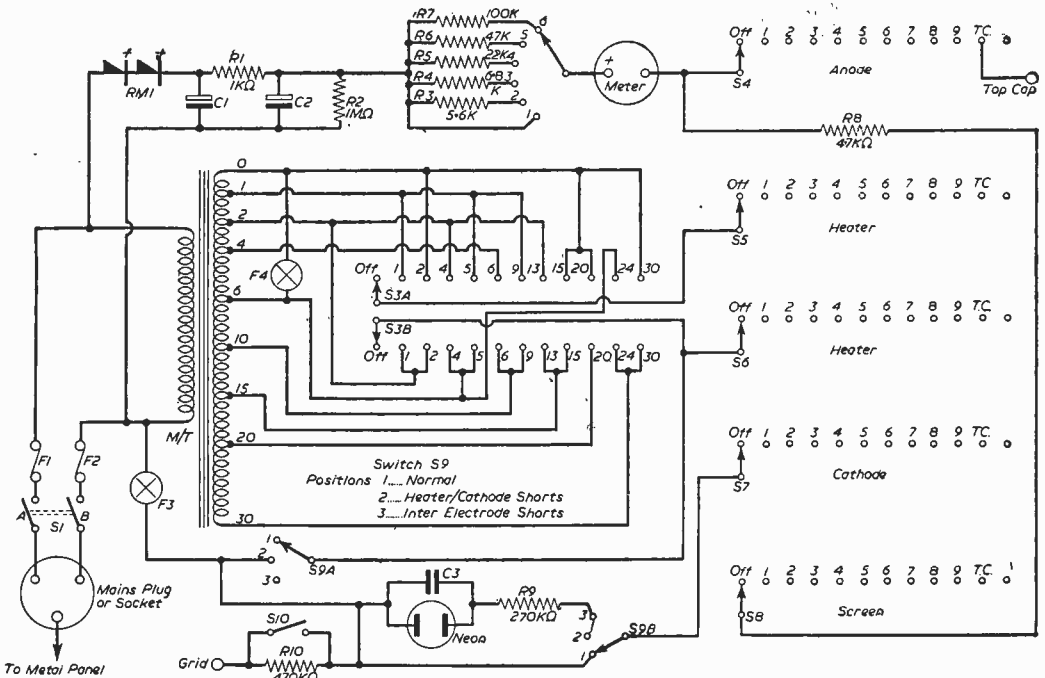

Fig. 7.—The complete wiring diagram (S9—position 1: normal, position 2: heater to cathode short, position 3: inter-electrode shorts).

it to the frame of the mains transformer. The block condenser and the electrolytic condenser are screwed down to the wooden side on the opposite side to the mains transformer. Wire up the rest of the switches and lamps and finally the 3 pin mains socket on the back panel.

**Testing**

Put all switches to the off position and switch on the mains switch S1 and check that there is H.T. at the anode and screen switch moving contact.

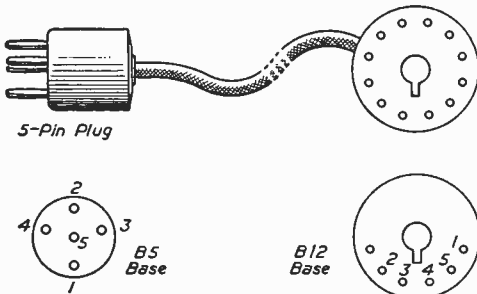

Fig. 8.—CRT adaptor.

If there is no voltage, then check back at the meter, then S2, the junction R1/R2 and finally at the rectifier. When the H.T. circuit is working, check the heater voltages and mark the switch to correspond. If you have no A.C. meter, check the circuit with a bulb (use a 2.5V bulb for the 1V and 2V positions and a 6V bulb for the 4, 5, 6V then a 12V bulb for the 9 and 13V positions). Use a 24V

**COMPONENTS LIST**

- Resistors:**  
 R1—1k 1W.  
 R2—1M ½W.  
 R3—5.6k 5W.  
 R4—6.8k 5W.  
 R5—22k 1W.  
 R6—47k 1W.  
 R7—100k 1W.  
 R8—47k 1W.  
 R9—270k ½W.  
 R10—470k ½W.
- Capacitors:**  
 C1,2 8+8µF 500VW.  
 C3 — 1µF paper 500VW.
- M/T Ellison LT133.  
 Neon Miniature M.E.S.  
 F1, F2 — 1A ½in. glass.  
 2 panel - mounting M.E.S. holders.  
 1 pilot light holder (M.E.S.).  
 F4 6V 0.3A bulb (M.E.S.).
- F3 6V 0.04A bulb (M.E.S.).  
 Meter 0 to 30mA, all similar.  
 2 w a n d e r p l u g sockets.  
 3 w a n d e r p l u g s.  
 1 crocodile clip.  
 2 RM1 metal rectifiers.  
 1 twin fuse holder.  
 S3 2-pole 12-way switch.  
 S4, 5, 6, 7 and 8 five 1 - pole 12 - way switches.  
 S1 D P S T toggle switch.  
 S2 1 - pole 6 - way switch.  
 S9 2 - pole 3 - way switch.  
 S10 S P S T toggle switch.  
 Valve Holders: B7G, B9A, B9, B5, B7, B8G, B9G, B8B, 1-0, M.0.

bulb for the 15, 20 and 24V positions. Now set switch S9 to the inter-electrode short position and (Continued on page 432)

# TELENEWS

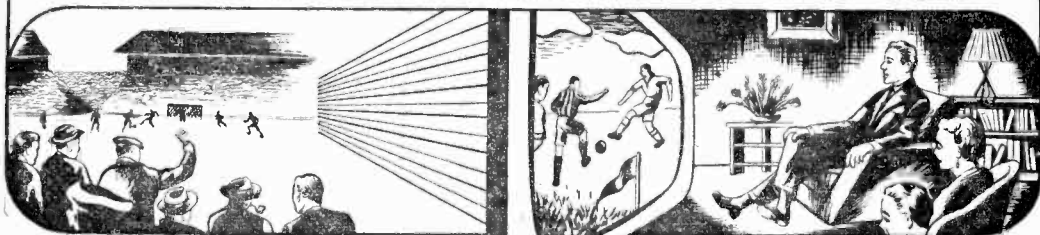

## Television Receiving Licences

THE following statement shows the approximate number of Television Receiving Licences in force at the end of February 1960, in respect of television receiving stations situated within the various Postal Regions of England, Wales, Scotland and Northern Ireland.

<i>Region</i>	<i>Total</i>
London Postal .. .. .	1,797,253
Home Counties .. .. .	1,395,472
Midland .. .. .	1,575,707
North Eastern .. .. .	1,690,966
North Western .. .. .	1,386,884
South Western .. .. .	870,360
Wales and Border Counties .. .. .	622,350
Total England and Wales .. .. .	9,339,972
Scotland .. .. .	689,535
Northern Ireland .. .. .	139,766
Grand Total .. .. .	10,368,323

## Westward TV's Studio Site

WORK on clearing the site for Westward Television's studios at Plymouth has begun. The site, 1½ acres in extent, fronts on Derry Cross and lies between the Atheneum and the Drake Cinema. When sinking preliminary test holes the contractors unearthed a quantity of human bones which were identified as those of French prisoners of war who were imprisoned here during the Napoleonic Wars. The bones were removed and re-interred. As excavation proceeds further similar finds are expected and local archaeological societies will be notified. Plymouth Corporation are the ground landlords.

## Independent TV in the Borders

THE Independent Television Authority will shortly be inviting applications from new groups wishing to become the programme contractor for its Border area. In this area, the Authority plans to build two transmitting stations. One station will be sited near Carlisle and its

coverage area will extend round the Solway Firth from Wigton to St. Bees Head and will take in the greater part of Kirkcudbrightshire and Dumfriesshire in Scotland, most of Cumberland and a large part of Westmorland. It is hoped to begin programme transmissions from this station early next year. The other station will serve the Tweed area between the Lammermuirs in the north and the Cheviots in the south. It is hoped to begin programme transmissions from this station around the end of 1961. Approximately half a million people live in the areas to be served by these two stations.

## ATV Buys Cameras

AN order for five of the latest Mark IV television camera channels has been placed by Associated Television Ltd. with Marconi's Wireless Telegraph Co. Ltd. These five channels will employ the English Electric Valve Company's 4½in. Image-Orthicon pick-up tubes. It is understood that they are for use in Associated Television's Wood Green Studios. A further twenty of these channels are being supplied to other U.K. users, including the BBC and Granada.

In the export field, despite its very recent introduction, the Mark IV has already made a considerable impact, some 65 channels having been ordered by the United States, Canadian,

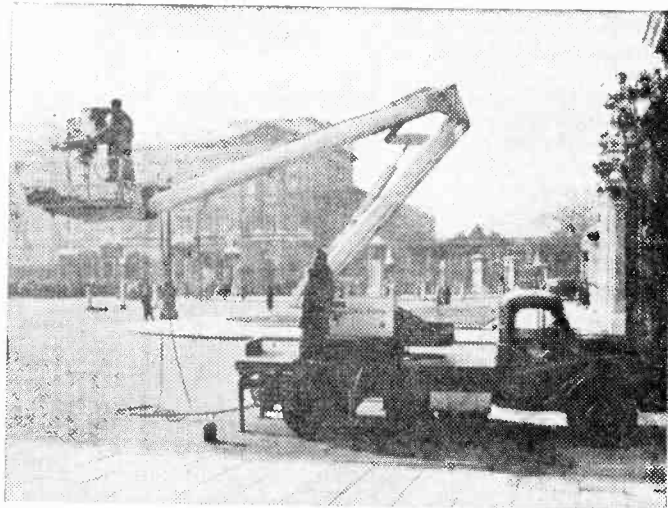

This photograph shows a BBC television cameraman checking over his camera equipment outside Buckingham Palace as he prepared his platform ready to start relaying pictures of the scenes there on the announcement of the birth of the Royal baby. The platform is capable of covering a very large area and has proved useful for many outside broadcasts.

Australian, Danish, Swiss and Italian Broadcasting authorities. One of the main features of the new camera channel is its extreme stability in operation, making virtually unattended operation possible, with a minimum of technical staff.

#### Montreux TV Festival

**N**EXT year's First International Festival of Television Arts and Sciences in Montreux, Switzerland, may be seen "live" on television screens in Britain and a dozen other European countries linked to Eurovision, including Russia, Poland and Czechoslovakia. Mr. C. Gillieron, Administration Office Director of the European Broadcasting Union which co-ordinates Eurovision, announced recently that he has notified all television organisations that the official Swiss Television Service is giving its full support to the Montreux Festival and has asked its fellow E.B.U. members to do the same. The E.B.U. meets in Amsterdam on April 23 for a week's conference and one of the major items on its agenda is the projected Montreux Television Festival.

#### Southern TV Figures

**F**IGURES recently issued by TAM Ltd. show at mid-February 569,000 homes, or 48 per cent of all households in the area, were able to receive ITV from either the Chillerton Down or the Church Hougham transmitter. Individuals in these ITV homes totalled 1,883,000, or eleven out of every 20 people living in private households in the area.

An analysis of the size of households shows that whereas 50 per cent of all households in the Southern ITV area had three or more persons living in them, 66 per cent of ITV homes were of this size. TAM adds that a survey covering the whole of the newly-defined Southern area is now in progress. The latest TAM estimate of the number of homes in the area capable of receiving Southern ITV programmes is 587,000 as at March 13, 1960.

#### TV Advertisements

**B**USY advertising executives can now see a complete TV commercial before a penny has been spent on filming, merely by looking up from their desks. One of the leading advertising agencies is now equipped with

an E.M.I. Electronics closed-circuit television and sound system in the basement TV studio of its London offices and receivers are located at key points throughout the six-storey building. Several of the receivers are situated in directors' offices, and another in the agency's private theatre allows communal viewing.

Important points like camera angles, permissible span of movement and suitability of colours for monochrome reproduction, can all be carefully examined and decisions reached in advance. Expensive filming time is then reduced to a minimum.

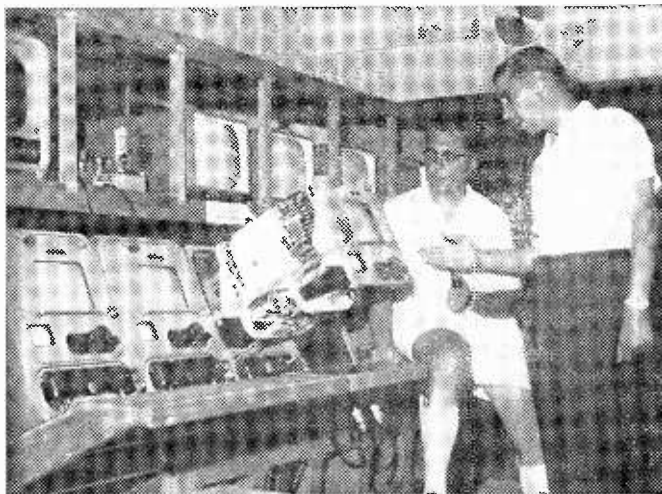

**Africa's first permanent television service is expected to have a viewing audience of over half a million by the end of the year. Nigerian maintenance and engineering staff are being trained to take over the operation of the service—under a contract awarded by the West Nigerian Government—by Marconi's who were responsible for the supply and installation of the transmitting and studio equipment. This photograph shows the Technical Operations Manager with the Station Manager in the Ibadan Control Room.**

#### "Remote Eye" at London Airport

**A**N experimental installation of closed circuit television has been completed at London Airport by Marconi's to enable the Authorities to determine whether the control of aircraft parking can be improved. At present a Marshalling Supervisor, situated in the main passenger arrival and departure building, relies on radio-telephony for reports of aircraft parking movements because his view of the parking area is restricted to that portion which lies in front of the building. A closed circuit television system is a possible means of improving

control in that it could give the Marshalling Supervisor visual information as to the numbers and disposition of the aircraft. To this end, two BD871 television cameras have been installed at the top of lighting stands, one at either end of a main parking area.

#### Special Trucks for TV Tubes

**A** NEW fleet of 17 Leyland Steer trucks will shortly be placed in service by London Carriers Ltd., who are to operate a 24-hour service transporting television tubes for Mullard Ltd. The new vehicles, which are to replace

a fleet of articulated outfits, will operate between the Mullard factory at Simonstone, near Burnley, and their Sywell distribution store in Northampton.

The new twin-steered six-wheelers have a overall length of 30ft and are fitted with bodies incorporating special roller floors manufactured by Cocker of Southport Ltd. Each body has internal dimensions of 24ft 2in. long, 7ft 6½in. wide and 9ft 3¼in. high.

Each vehicle will carry 840 television tubes, the tubes being packed in boxes and then in pallets. Each pallet will carry three boxes containing ten tubes.

# Power Supply Circuits for TV

DESIGN AND OPERATION

By J. Kemp

THE majority of TV owners have A.C. mains, and not always with the optimum amount of receiver protection. A study of many designs particularly home-constructed shows that the cheapest of all protections, the fuse, is by no means standard. There is absolutely no justification for the omission of fuses, whereas there is a great deal to be said in favour of them. When selecting the correct rating normal load figures are desirable, for the more that is known about normal conditions the greater the protection that can be obtained from the "link" in the power supply that is deliberately made weak. Many readers will need no advice or guidance about fuses, but in television ownership and construction, as in all things, there are the interested newcomers who rather than leave out a good point will accept values from similar apparatus. To copy other values is to grade the whole business rather broadly and is risking expensive trouble.

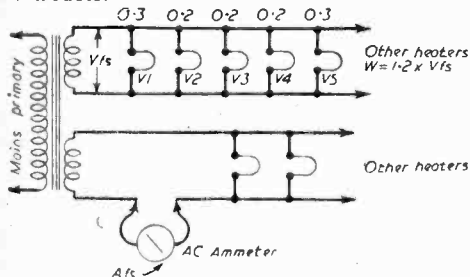

Fig. 2.—Checking heater currents.

Fuses, by their very nature and intended usage, are made quite cheaply: it is far better to spend a shilling or two on over-caution than spend pounds for lack of any care at all. Domestic supply fuses cannot protect a receiver, for their ratings must cover loads other than the set itself and consequently such fuses would allow currents that could do much damage to the TV without "breaking".

A good average value for normal protection is given by:

$$R = 1.5 \left( \frac{ImA \times Vht}{1,000} + \frac{Afs \times Vfs}{Vmi} \right)$$

Where: *ImA* is total receiver H.T. current—milliamperes (Fig. 1) *Vht* is receiver H.T. (smoothed D.C.) voltage (Fig. 1) *Afs* is total valve heater currents in a parallel run (Fig. 2) and *Vfs* is heater voltage of one valve in such parallel runs. Where several secondaries are found and their voltages differ, the respective wattages are added together, but where such separate secondaries have a common voltage then only the value of one need be considered against the total currents of the related windings. *Vmi* is the mains input voltage.

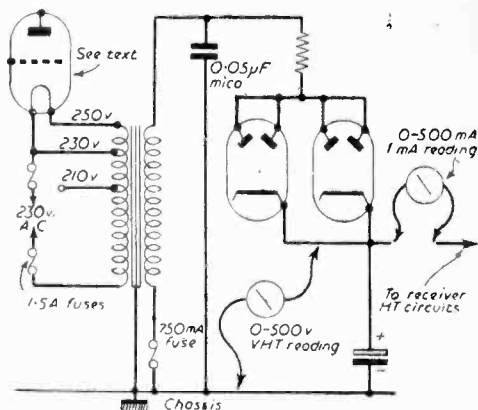

Fig. 1.—Checking current for load values.

As beginners are mostly concerned at this point an example may not be amiss. Assuming *ImA* as 300, *Vht* as 300, *Afs* and *Vfs* as 25 valves with 6.3V 0.3A heaters and a *Vmi* (mains input volts) value of 250, the resultant rating is 0.8, but this would be carried to 1A in practice and allows for transformer losses involved. As the formula assumes blow-out on 50 per cent overload it should be closely followed for best protection, and in this respect where fractional answers occur discretion should be used in "rounding off" the figure.

### Series Heaters

Some receivers, though designed solely for A.C. mains, also employ a type of modified A.C./D.C. technique for valve heaters as in Fig. 3. Where such circuits occur the total wattage is *V<sub>1</sub>I* where *V<sub>1</sub>* is the voltage across the entire winding and *I* is the current in amps. of one valve only. In some cases also shunt resistors may be employed where valves of "odd" current ratings are included in series heater chains. Suppose it is desired to include a 12.5V 0.15A type in a chain of valves of varying heater voltages but identical current ratings (as they should be if no series or parallel ballasts are used). Then the system in Fig. 4 (for 0.3A) would be used and the chain current is that of the valves not shunted, the odd valve rating not being considered as the shunt compensates for the difference. However, if the chain consisted of 0.15A types, and a 0.3A type were inserted, then the system of Fig. 5 would be needed and the chain current then becomes that of the higher-current valve, in this case 0.3A. It will be noted that the "odd" valve is placed to avoid an additional shunt as would be required if the valve were set in an intermediate

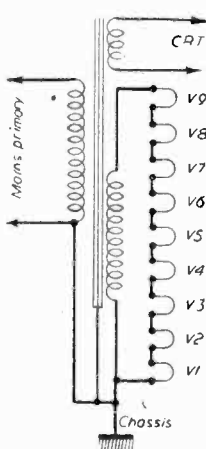

Fig. 3.—The modified A.C./D.C. circuit for heater supplies.

position. Where mains transformers have tapped primaries for correct loading, the differences existing between such taps (in typical cases 10 volts; inputs 210-230-250 etc.) can be used (Fig. 1), where practicable for low current loads. An odd valve heater voltage can be supplied by such taps, but no great load should be so imposed, for primary windings are gauged for primary currents. The point is raised as a caution and also concerned is the after-caution necessary for with such "stunts", carelessness can lead to violent shock from the heater of the valve so connected.

Where A.C./D.C. techniques are contemplated (by constructors) the drawbacks of such systems should be overcome or limited. Not the least snag is the possibility of chassis being "live" at full mains potential and a definite hazard to life. The writer is surprised by the attitude of many to any talk of shocks and care to avoid them. Perhaps such attitudes are bred by the apparent inability of A.C. mains to give lethal doses in most cases of contact. However, circumstances vary, as do physical health levels, and survival of shocks may be due entirely to conditions favouring persons involved, which is no guarantee that such will always be the case. Many fatal accidents concern persons that have often received shocks before and when, perhaps, familiarity bred contempt! Take no chances.

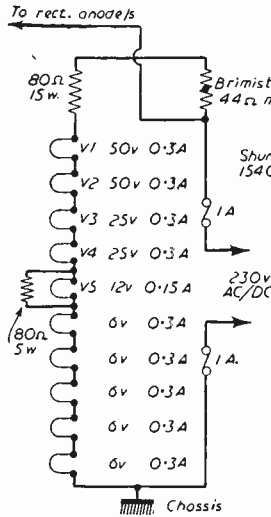

Fig. 4.—Using "mixed" valves in a chain.

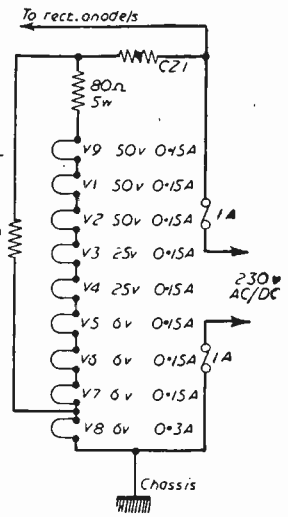

Fig. 5.—Another modification where only one valve is different.

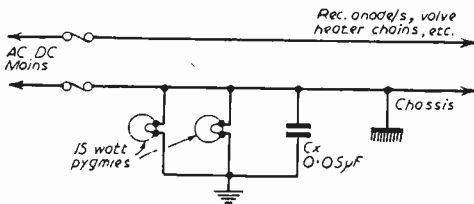

Fig. 6.—Protecting the chassis on an A.C./D.C. receiver.

The circuit of Fig. 6 shows a simple arrangement that will give excellent protection against "live" chassis and associated risks. It will enable readers interested to ensure that apparatus can be handled safely, and many constructors must wish to leave a newly-built job open for adjustments, modifications and the like. A true earth is necessary, but as shown it should not be taken to chassis except through the condenser Cx. Two lamps are shown in the circuit, though one will do quite well. Two are in Fig. 6 to allow for the possibility of the chassis not being indicated by reason of lamp failure.

Whilst discussing A.C./D.C. drawbacks, the popular negative resistance elements must be

included. Former protections against surges consisted, in the main, of barretters, ballast tubes, etc., and such devices usually dropped the surplus voltages in heater strings whilst maintaining constant current over fluctuating voltage values. A modern system is the thermistor, and when these are used the manufacturer's recommendations should be followed. Details are published of operating temperatures and particular note should be made of the minimum value to which each type falls (value of resistance). Allowance should definitely be made for such a minimum working figure and, taking one example, one type starts at 3,000Ω cold and absorbs surges by reason of this. However, as it warms so its resistance drops, but according to maker's data at full operating temperature its resistance when passing 0.3A is 44Ω. If this is not considered then the valve or valves will be under-run by an average of 13V. Fig. 7 shows a typical heater chain, and it will be obvious that A.C./D.C. type valves should always be used in such schemes. The resistance RKP represents the cathode resistors of associated valves all in parallel, as they are so far as stresses are concerned. The resultant value is very low as calculation from typical values will prove, and for this reason valve-heater chains are arranged so that the high-voltage heaters "bear the brunt".

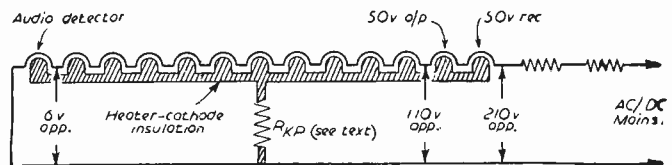

Fig. 7.—Diagram illustrating heater-cathode insulation.

# TELEVISION TURNTABLE

A NOVEL SPACE-SAVING  
UNIT

By R. Hawkins

ONE of the problems in a small house is the lack of space, especially adjacent to the fireplace. This area usually houses an armchair, or a television set, but not quite both.

This was overcome in my home by fitting a quadrant turntable into the dividing wall between dining room and lounge. If it is con-

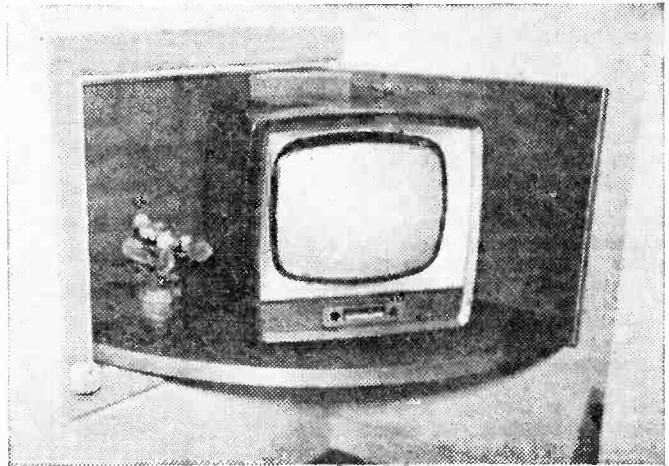

The completed turntable.

is placed in front of the fire and the turntable revolved into the room to the viewing position. After viewing is over, both are returned to their original positions.

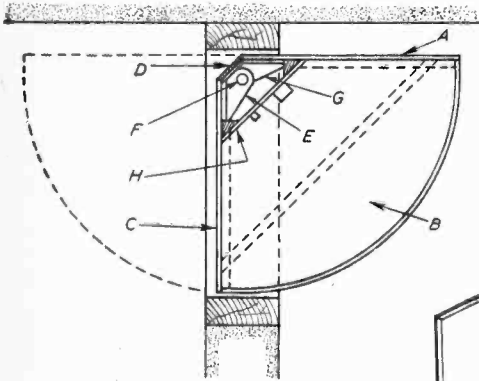

Fig. 1.—A plan view of the unit.

venient to use only one room, the television is kept in the vacant room and the armchair is placed in the alcove at the fireside. When viewing is desired the armchair

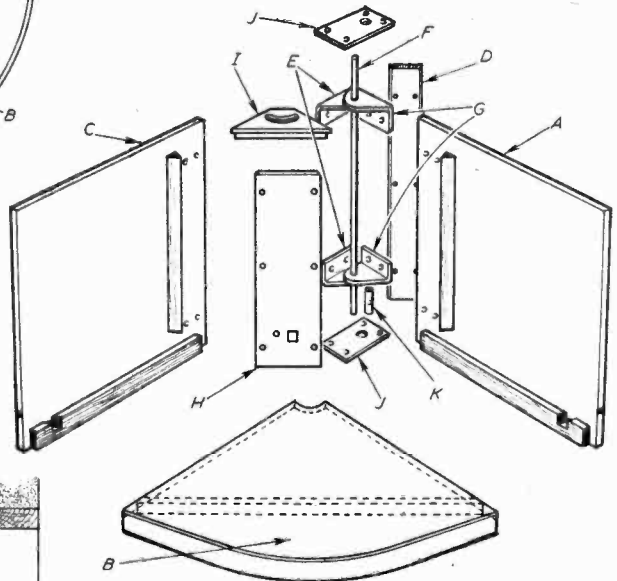

Fig. 2.—An exploded view.

In Figs. 1 and 2, the doors (a) and (c) were made from  $\frac{1}{2}$  in. thick oak-faced "Weyroc" edged with a ramin bead. Battens were attached to carry the table top (b), also made from "Weyroc" and ramin bead.

A  $\frac{1}{2}$  in. diameter M.S. shaft was used as a hinge pin located in two  $\frac{1}{2}$  in. M.S. plates (j). The hinge brackets (e) and (g) were made from L.A. angle bolted on the doors. A spacer made from  $\frac{1}{2}$ -in. dia.

(Continued on page 432)

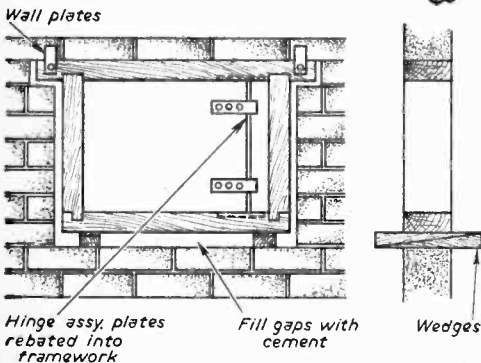

Fig. 3.—Mounting the wooden framework.

# Aerial Feeder Matching

USING A COMMON  
DOWNLOAD WITHOUT A  
DIPLEXING CIRCUIT

By J. Frith

WITH the increasing coverage of television transmitters on Band III, many amateur constructors find themselves confronted with the problems of design for VHF for the first time, and also with the installation of the more elaborate types of aerial required, in most cases, to deal with the weaker field strength of the Band III transmission. The simple two-element array of dipole and reflector, so often used on Band I, presented no difficulties, as by using almost any type of low-impedance feeder, according to the requirements of the receiver, satisfactory operation of the aerial could be assured. But in the installation of a multi-element array for Band III it is not practical merely to connect aerial to receiver by the first available length of feeder, as quite serious losses may occur by so doing. In addition the aerial system has now to provide two signals of widely different frequencies and more problems arise when it is intended to connect both aerials to a single download. However, by the application of some simple theory to the design of the feeder system, these difficulties may easily be overcome and maximum performance of the aerials assured.

## Matching the Band III Aerial

As more directors and reflectors are added to the simple half-wave dipole to make a multi-element array, the radiation resistance at the centre of the dipole, about 80Ω in free space, drops sharply. For a four-element array it is of the order of 6 to 8Ω. A feeder constructed to match this impedance would have impossibly close spacing and thus a means of increasing the radiation resistance must be found. The commonest is the so-called folded dipole, almost universally used in aerials for Band III. The folded dipole is fundamentally two half-wave dipoles in parallel, connected together at the ends with the feed taken from the centre of one of them. If the two conductors have the same surface areas (e.g., made from the same diameter tubing) the aerial current divides equally between the two, and the radiation resistance at the feeder terminals is

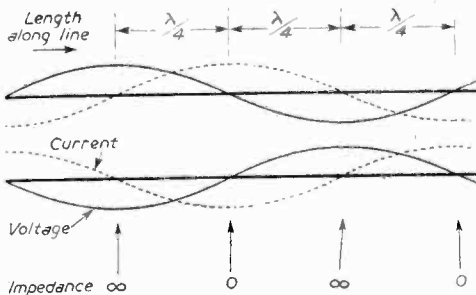

Fig. 2.—Diagram of voltage-current relationship on a transmission line.

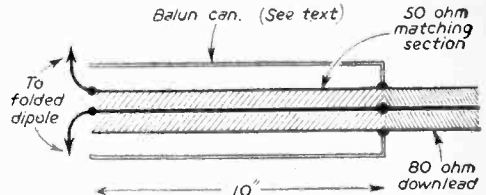

Fig. 1.—Construction of the Band III matching section.

multiplied by four. Thus the feeder impedance required to match a four-element folded dipole array is of the order of 30Ω. If 72 or 80Ω cable is used to the receiver, a mismatch will be produced, which, although it may not be very serious, will result in increased losses and reduced efficiency.

The simplest matching device for coaxial cable is the "quarter-wave transformer". This consists of a quarter-wavelength of coaxial line connected between the two impedances it is desired to match. If the two impedances are denoted by Z1 and Z2, then the impedance of the quarter-wavelength section

$$Z_c = \sqrt{Z_1 Z_2}$$

If a section of 50Ω cable is used it will provide a match to 31.25 from 80Ω cable, which can then be used for the download.

## The "Balun" Converter

As the outer conductor of coaxial feeder is earthed at the receiver end, the two halves of the folded dipole will not be balanced equally about their earthed centre point, resulting in distortion of the polar diagram of the aerial and pick-up from the feeder. The conversion of an unbalanced coaxial line for use with a balanced aerial termination is accomplished with a so-called "balun" (balance-to-unbalance) converter. The most practical form is known as the "quarter-wave can", and consists of an additional coaxial screen, a quarter wavelength long, placed around the existing feeder at the aerial end and connected to the outer screen of the feeder at the end farthest from the aerial (see Fig. 1). The end nearest the aerial is coincident with the end of the outer screen of the feeder, but insulated from it. The outer conductor will now effectively be earthed and the two connected to the aerial will be able to move in antiphase with respect to earth—with a folded dipole, its centre point.

A balun converter may easily be constructed using a length of heavy 1/4 in. coaxial cable from which the centre conductor and polythene dielectric have been removed. The braid screen and outer covering are slipped over the feeder and the end soldered to a bared section of the outer conductor of the feeder. If the converter is used with a quarter-wave matching transformer as well, it will start at the same point, and all three cables must be carefully soldered together as shown in Fig. 1. Great care must be taken not to short the inner conductor to the screens, or to distort the polythene by application of too much heat when soldering the screens themselves. The outer covering of the heavy cable can then be pulled down over the joint and trimmed at the aerial end, making sure that the two braid screens do not touch at this point. The cable ends may then be waterproofed with adhesive, or other suitable compound.

When calculating the length of a quarter-wave the "velocity factor" of the cable must be considered.

$$\text{Velocity factor} = \frac{\text{Velocity of wave in feeder}}{\text{Velocity of wave in free space}}$$

Or, for any one frequency:—

$$\text{Velocity factor} = \frac{\text{Wavelength in feeder}}{\text{Wavelength in free space}}$$

Thus, to obtain the length of a quarter-wave in a feeder, the natural quarter-wavelength must be multiplied by the velocity factor of the cable used. A round figure for polythene-spaced coaxial cables is 0.66. For Channel 9, a quarter-wavelength in coaxial cable is almost exactly 10in.

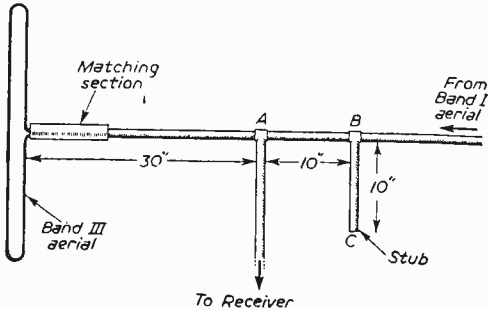

Fig. 3.—Construction of the complete feeder system for Bands I and III.

When two feeders from two separate aerials are connected to a single line for connection to the receiver, a device must be used to prevent each aerial, with its own feeder, from interfering with the other. A Band III signal received on its aerial, when passing the junction of the feeder to the Band I aerial, must "see" an infinite impedance in the direction of the Band I aerial, and the same applies conversely to the Band I signal. If this is not so an impedance mismatch will occur at the junction and the signal from each aerial will be mixed with a smaller signal received on the other aerial, resulting in the spoiling of the polar diagrams of both aerials. This problem is solved commercially by the use of a pair of filters incorporated in a "junction box", the filter in the Band I lead being adjusted to reject signals in Band III, and vice versa. The design and construction of such filters is not impossibly difficult for the amateur, but it is possible to effect the same result without using them by attention to the feedlines themselves.

#### Stubs

The principle used is a familiar one at radar frequencies, where it becomes invaluable. On a resonant section of transmission line the impedance (voltage-current ratio) varies sinusoidally along the line. For a perfect line the impedance at points of no current is infinite, and where there is no voltage the impedance is zero (see Fig. 2). Thus, if the line is physically short-circuited at such a point, the operation of the line is unaffected. A quarter-wavelength away, however, the voltage is at its maximum, and there is an infinite impedance. If any point on a feeder is physically short-circuited, thus introducing zero impedance, a quarter-wavelength away the impedance of the line

will appear to be infinite to that particular frequency, and a further quarter-wavelength away it will appear to be zero again. Also, if a length of line is terminated in an open-circuit, a quarter-wavelength from the end it will appear to be short-circuited, and so on.

Thus, to produce a reflected open-circuit at any selected point on a feeder, one may instead produce a short-circuit at a distance of one quarter-wavelength from it. But this short-circuit may also be artificially produced, e.g., by connecting to the line a quarter-wavelength of feeder open-circuited at its other end. This length is called a stub. In Fig. 3, a stub is seen connected to the Band I feeder a quarter-wavelength away from the junction and a quarter-wavelength long. To a Band signal the open circuit at point C is reflected as a short-circuit at point B, and this short-circuit appears as an open circuit at point A, the feeder junction. Thus, a Band III signal "sees" an infinite impedance along the Band I feeder. If desired, another open quarter-wave stub may be connected a further half wavelength along the line. This, it will be seen, will reinforce the effect of the first.

The construction of the stub is as simple as it looks. To insulate the junction of the inner conductors a short piece of polythene tubing may be used drilled through one side to take the stub and slit lengthwise through the hole to allow it to be slipped over the junction. The polythene from the cable used for the halun converter is most suitable for this purpose. The braiding should then be wrapped around the junction and carefully soldered in position. The completed stub can then be laid along the feeder, encased in a length of sleeving.

To prevent the Band III array from affecting the Band I signals the same principle is applied. Where a folded dipole is used for Band III reception, the ultimate end of the entire Band II feeder system is a short-circuit at the centre of the folded dipole. Thus, if the total length from this point to the feeder junction is made a quarter-wavelength at the Band I frequency, an infinite impedance will appear at the junction as "seen" by the Band I signal. It is sufficiently accurate to regard the velocity factor of the actual folded dipole, considered as a transmission line at Band I frequency, as being unity, so that if the length round one leg of the dipole is subtracted from a natural quarter-wavelength at the Band I frequency, and the remaining length multiplied by the velocity factor of the cable used the length of the feeder required for the Band III aerial is obtained.

#### Testing

The performance of the junction system is easily tested. With the receiver tuned to Band III the signal strength is observed while the Band I feeder is disconnected from the junction, and also when it is shorted and open-circuited beyond the stub. Absolutely no variation should be seen. When tuned to Band I there should again be no change in signal-strength when the Band III feeder is disconnected and reconnected at the junction.

REMEMBER TO BUY  
OUR COMPANION JOURNAL  
PRACTICAL WIRELESS  
1/6 Every Month



TUBES · TUBES · TUBES · TUBES

# Harverson's Hit the Jackpot!

## FIRST 500 CUSTOMERS

Fully Guaranteed

### COSSOR

### 10" 108K TV TUBES

Equivalent H.M.V. 3/16

BRAND NEW **NOT** REGUNNED ★ UNREPEATABLE VALUE

# 15' - POST FREE

## HARVERSON SURPLUS CO. LTD.

83 High Street, Merton, London, S.W.19

(one minute South Wimbledon Tube)

TUBES · TUBES · TUBES · TUBES · TUBES · TUBES · TUBES · TUBES · TUBES · TUBES

TUBES · TUBES · TUBES · TUBES · TUBES · TUBES · TUBES · TUBES · TUBES · TUBES

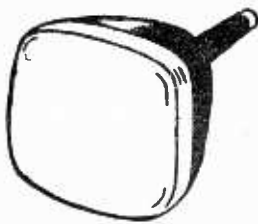

# TV PICTURE TUBES

BUY DIRECT FROM FACTORY

**TRADE ENQUIRIES INVITED**

**SAVE UP TO £8**

12" & 14"

15" & 17"

**£5-19-6**

**£6-19-6**

- ★ 12 months' guarantee
- ★ Cash allowance for Old Tube
- ★ All Types
- ★ Free advice on fitting

Carriage and Packing 10/- extra.

Send cash with order or C.O.D. giving size and type of tube required to:—

**HOMEVISION SERVICES**  
17 OXFORD STREET, SWANSEA

## VALVES SAME DAY SERVICE

NEW ! TESTED ! GUARANTEED !

**SETS**

1R5, 1S5, 1T4, 3S4, 3V4, DAF91, DF91, DK91, DK92, DL92, DL94, any 4 for 23/6  
DAF96, DF96, DK96, DL96  
6K7G, 6K9G, 6Q7G, 6V9G, 6X5G, or 5Y3G . . . . . 4 for 30/-  
5 for 27/-

1A7GT 12/-	6L1 15/-	25Z4G 8/-	EBC41 8/6	EY86 8/3	PZ30 17/-
ID5 8/-	6L18 12/3	25Z6GT 9/6	EBF80 8/-	EZ40 6/9	SP61 3/6
1R5GT 10/-	6P25 9/-	30C1 7/3	EBF89 8/9	EZ41 7/6	T41 15/6
1N6GT 10/-	6Q7G 8/9	30L1 7/9	EEL21 20/6	EZ80 6/3	U25 13/-
1R5 6/9	6Q7GT 9/6	35L6GT 10/-	EC92 11/-	EZ81 7/-	U25 11/6
1S4 5/9	6SL7GT 6/3	35Z4GT 8/6	ECC81 5/9	FW4/500 8/-	U50 7/6
1S5 5/9	6SN7GT 4/9	35Z5GT 8/6	ECC82 6/6	GZ32 9/-	U76 6/-
1T4 4/9	6U4GT 11/-	43 8/-	ECC83 7/-	KT33C 7/-	U78 6/-
1U5 6/8	6V9G 5/-	50CD6G 28/9	ECC84 8/9	KT41 14/6	UABC90 7/9
3A5 10/6	6V8GT 6/6	50L6GT 8/9	ECC85 8/3	KT61 10/-	UAF42 9/6
3C4 8/8	6X4 5/-	AZ31 9/6	ECF80 10/-	KT63 6/6	UBC41 7/9
3V4 6/9	6X5GT 5/6	B36 8/9	ECF82 10/-	KT71 8/6	UBF80 9/6
5U4G 7/6	7B7 7/6	CL33 13/-	ECH21 20/6	MH4 6/-	UBF89 8/6
5Y4G 9/6	7C3 7/6	DAC32 10/-	ECH35 8/9	PCF80 12/3	UBI21 20/6
5Y3GT 8/9	7H7 7/6	DAF91 5/9	ECH42 8/9	PCF82 9/3	UCB4 12/9
5Z4G 7/9	7S7 9/9	DAF96 7/9	ECH81 8/6	N18 8/6	UCB5 7/6
6AL5 3/9	7Y4 7/-	DC90 10/8	ECL80 8/-	PCC84 7/9	UCF80 14/-
6AM5 3/6	10C1 14/6	DF33 10/-	ECL82 10/-	PCC89 12/3	UCH21 20/6
6AQ5 6/3	10C2 17/6	DF91 4/9	EF39 4/6	PCF80 7/3	UCH42 9/-
6AT6 7/3	12AH 15/6	DF96 7/9	EF41 8/9	PCF82 9/3	UCI61 8/6
6BA6 6/-	12AT7 5/9	DH76 6/6	EF42 11/6	PCL82 9/3	UCL82 10/9
6BE6 6/-	12AQ6 7/6	DH77 7/3	EP80 6/6	PCL83 14/6	UCL83 13/-
6BH6 5/9	12AU7 6/9	EK32 12/-	EP85 8/9	PCL84 8/-	UF41 8/9
6BJ6 5/9	12AX7 7/-	EK40 14/-	EP86 10/6	PCNA4 11/-	UF42 7/6
6BR7 10/9	12BA6 8/-	EK91 6/9	EP89 8/-	PEN36C 8/6	UF89 8/6
6BW6 8/6	12K7GT 5/6	EK92 8/6	EP91 3/6	PEN45 8/-	UL41 8/-
6BW7 8/6	12Q9GT 5/6	EK96 7/9	EP92 4/6	PEN46 5/6	UL84 8/-
6CD6G 22/6	12Q7GT 5/6	DL33 9/-	EL33 10/-	PL36 11/9	URIC 8/-
6F1 14/6	12Z3 7/6	DL35 10/6	EL38 21/6	PL38 14/6	UY21 11/3
6F8G 6/6	14S7 16/9	DL42 8/6	EL41 9/-	PL41 9/6	UY41 6/6
6F13 12/6	14T7 7/6	DL94 7/6	EL42 10/6	PL82 7/6	UY85 9/9
6F14 17/6	20F2 17/6	DL96 7/9	EL84 7/-	PL83 8/-	VP4B 8/6
6K7G 8/6	20L1 17/6	EABC90 7/-	EM34 8/6	PY32 12/-	VP41 6/-
6K7GT 8/6	25A6 10/-	EAC21 4/6	EM30 9/-	PY30 7/6	W76 6/6
6K9G 6/9	25L6GT 9/-	EAF42 8/6	EM81 9/-	PY81 6/9	W77 4/6
		EB91 3/9	EM84 10/-	PY82 7/-	X76M 11/6
		EBC33 5/-	EY51 9/-	PY83 7/9	Z77 3/6

**READERS RADIO**  
24, COLBERG PLACE, STAMFORD HILL,  
LONDON, N.16. STA. 4587

## 1960 EDITION RADIO AMATEUR'S HANDBOOK

By The A.R.R.L.

32/6 Postage 2/-

- HI-FI AMPLIFIER CIRCUITS. By E. Rodenhuis. 15/- Postage 9d.
- HOW TO GET THE MOST OUT OF YOUR VOLTMETER. By T. Jaski. 23/- Postage 1/-.
- RAPID TV REPAIR. By G. W. Heath. 23/- Postage 1/-.
- USING AN OSCILLOSCOPE. By D. W. Easterling. 6/6. Postage 6d.
- OSCILLOSCOPE TECHNIQUES. By A. Haas. 23/- Postage 1/-.
- TV FAULT FINDING. A Data Pub. 5/- Postage 6d.
- TELEVISION RECEIVING EQUIPMENT. By W. T. Cocking. 30/- Postage 1/3.
- IMPROVE YOUR RECEPTION. By J. Cura and L. Stanley. 5/- Postage 6d.
- RADIO VALVE DATA. Compiled by "VVV". 6th Ed. 5/- Postage 9d.
- NEW 1960 CATALOGUE. 1/-

## THE MODERN BOOK CO.

BRITAIN'S LARGEST STOCKISTS of British and American Technical Books

19-23 PRAED STREET,  
LONDON, W.2.  
Phone: PADington 4185.  
Open 6 days 9-6 p.m.

Post 6d. per valve extra.  
Any Parcel Insured Against Damage in Transit 6d. extra.  
Any C.O.D. Parcel 2/6 extra.

# I.F. WOBBULATOR

## VISUAL INDICATION OF VISION I.F. RESPONSE CURVES

By D. R. Bowman

**M**OST experimenters in television are concerned with picture definition, and it can be a tedious business seeking it without suitable equipment. Here is described a cheap and efficient apparatus which, with the aid of an oscilloscope, will enable the constructor to be sure of one factor at least—the important one of “response curve”—in his circuit adjustments.

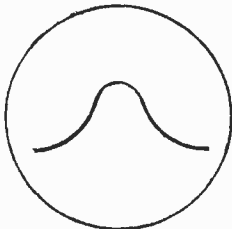
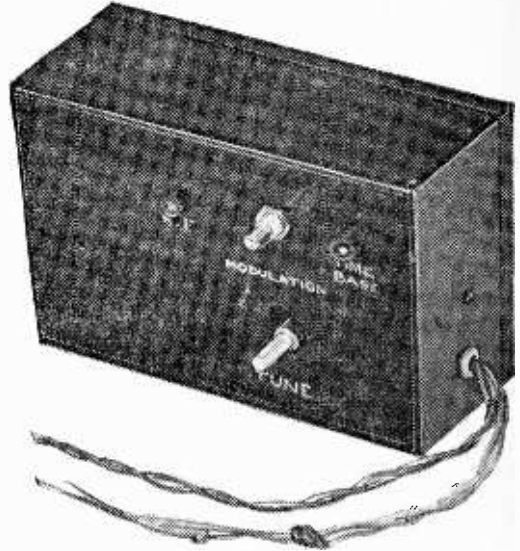

Fig. 1.—A typical trace for a single tuned circuit.

of an oscilloscope, the output of the oscillator is connected to the input of the amplifier, and the voltage developed at the detector is fed to the Y plates of the oscilloscope tube—amplified as necessary. If the timebase generator is set to a low speed—say, 10 sweeps per second—and the oscillator is swept through the I.F. at the same speed, the response curve of the amplifier appears on the screen of the CRT. A moment's consideration will show the reason for this. Away from resonance the amplifier is off tune and only a small voltage is developed at the detector. As the frequency approaches the tuning point of the amplifier the detector voltage will increase, and since the spot will have moved (towards the centre of the trace, usually) it will be deflected vertically. At the point of resonance—if a single tuned circuit is taken as the simplest example—maximum voltage is developed at the detector, and the spot on the tube face undergoes maximum deflection. As the generated oscillations increase in frequency, off-tune conditions

### Principles

The aim of the designed circuit is to produce an oscillator which can be varied in its frequency so as to sweep through the nominal intermediate frequency of the I.F. amplifier. In order to show the response curve of the receiver on the face of the tube

are again met and the deflection of the spot decreases. A typical trace curve for a single circuit is shown in Fig. 1.

### Conditions of Design

Certain conditions have to be met in the design of such a “wobulator”. Firstly, there must be automatic means of sweeping the oscillator frequency through the nominal I.F. of the amplifier. Secondly, this process must repeat at a high enough rate to show an apparently continuous trace on

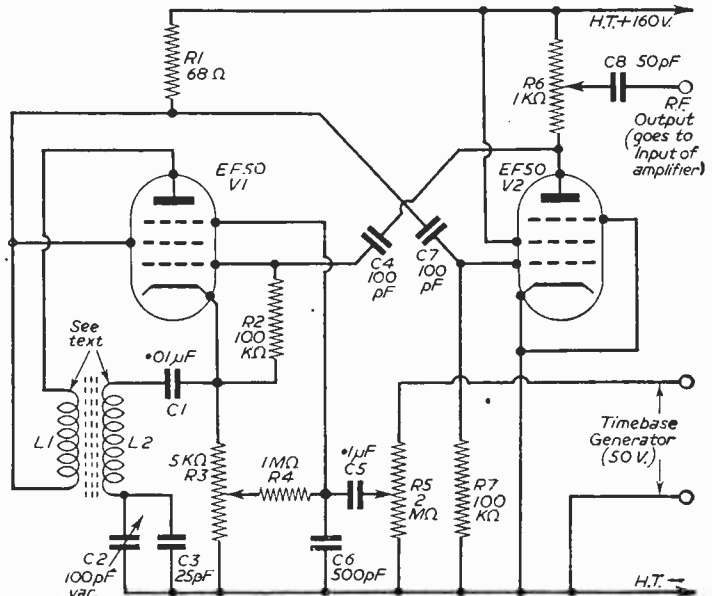

Fig. 2.—The circuit diagram of the wobulator.

the CRT. The third condition is that this must not be done at too high a rate, otherwise the tuned circuits, if highly selective, cannot respond in time and a distorted trace results. Five to ten traces a second is good enough, and with large-bandwidth amplifiers 50 per second will do, though it is really too high a rate of sweep. Fourthly, the oscillator must swing completely through the I.F. and where considerable bandwidths are involved this is a limiting feature of design.

The timebase generator of the oscilloscope will produce a linear sawtooth voltage, and if this can be caused to produce a considerable linear variation of oscillator frequency, the problem is solved.

### Frequency Variation

The writer tried several methods of varying the oscillator frequency before settling on the present circuit. The normal method, using a "reactance valve" proved to have two faults at the usual television I.F.—it was impossible to achieve a large enough sweep without generating at a low frequency and multiplying up, and also the variation of frequency was not linear with a linear sawtooth voltage. The use of a Miller valve across the oscillator tuned circuit gave a better sweep, but the frequency change was not linear. In both cases four or five valves would have been needed to give reasonable results, because of the correction involved. The mechanical method is attractive—using a motor-driven variable condenser to tune the oscillator—but it is a little unreliable, and does not lend itself well to low speeds of "wobulation". It is, moreover, not elegant.

### The Circuit

The circuit eventually adopted is shown in Fig. 2. Valves V1 and V2 together comprise a multivibrator of low output. It does not give a rectangular waveform because of this, and because of the fact that it is "locked" to a tuned circuit consisting

essentially of L2 and C2 in series. (C1 is merely a H.T. blocking condenser.)

The timebase voltage, at about 20-30, is fed to the suppressor grid of V1. The action can be visualised as follows: the actual analysis is complex.

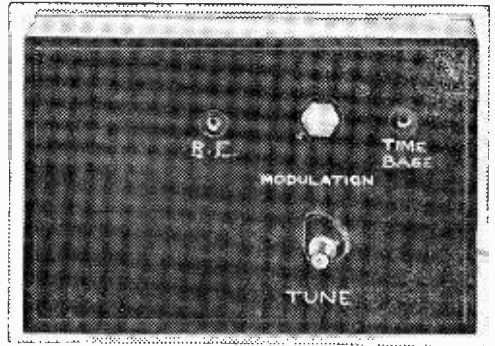

Front panel.

Consider the suppressor of V1 very negative; then all the valve current is diverted to the screen and L1 (which is coupled closely to L2) is virtually open-circuited and has no action on the tuned circuit L2/C2 apart from its capacitance. Thus the oscillatory frequency of L2/C2 is almost unaffected by L1. Now if the suppressor becomes positive nearly all of the cathode current goes to the anode and thus flows through L1. This is now an active part of the tuned circuit because of its mutual inductance with L2; the frequency of oscillation therefore changes. Since the degree of effective coupling between L1 and L2 varies with the suppressor grid voltage, the time-base voltage on the suppressor varies the frequency of oscillation.

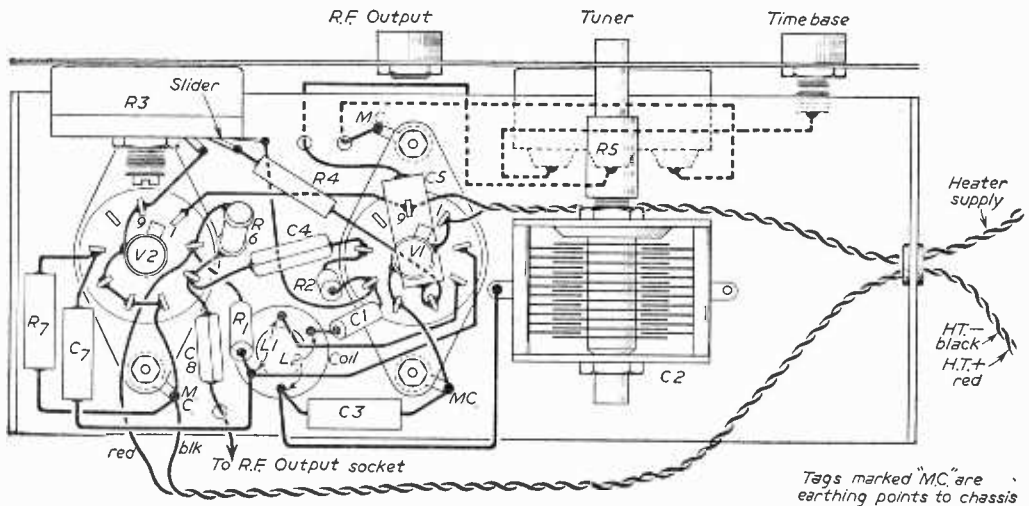

Fig. 3.—Underchassis wiring details. (Note that C6, wired between the junction of R4 and C5 to chassis, has been omitted for clarity. Resistor R6 is here shown as a fixed resistor but a potentiometer may be used as indicated in Fig. 2.)

**Construction**

The construction is simple enough and calls for no special precautions other than those usually adopted when circuits have to cope with frequencies of 10-50Mc/s. The components shown should, of course, be of good quality and low loss. All condensers below 500pF in value should be of mica or ceramic manufacture. With the coils L1 and L2, as now described, the fundamental frequency of oscillation is about 8Mc/s, but can be varied to about 14Mc/s. Up to the fifth harmonic can be used effectively, and thus the following ranges are covered:

- 8-14Mc/s      32-56Mc/s
- 16-28Mc/s    40-90Mc/s
- 24-42Mc/s

If the higher harmonics are not sufficiently prominent the anode resistor of V1 can be increased to, say, 1000Ω.

Coils L1 and L2 both consist of 14 turns of 24s.w.g. enamelled copper wire, close-wound on a 0.4in. Aladdin former with an iron dust core. L2 is wound on top of L1, with an insulating layer of tape (transparent plastic) between. The cathode end of L2 should be directly next to the anode end of L1.

**Adjustment**

Adjustment is simple. First, a meter is inserted in the cathode lead of V1 (i.e., in series with the 5k resistor) and the standing bias on the suppressor is varied until the valve current is minimum. This is not a critical adjustment, and if preferred this control can be omitted, using a 2.2k resistor instead of the 5k in the cathode lead; in this case the suppressor grid lead is returned direct to earth.

Next, setting the variable condenser C2 at about half its travel, adjust the core of L1-L2 until the frequency generated is about 9Mc/s, the sweep control R5 being set to zero. The wobulator is now ready to use.

The only connection not shown in Fig. 2 is that between the amplifier detector and the oscilloscope. For this, a 10k resistor should be attached to a flex lead; the other end of the resistor is connected to the diode anode or the volume control slider, and the free end of the flex connected to the Y-amplifier input of the oscilloscope. The 10k resistor will avoid instability due to the connection, and if this is not enough, try a 'screened lead or increase the value, up to 500k if necessary.

**Curve**

It should be noted that the response curve may easily come out "the wrong way up"; it depends on which way round the diode detector is connected. Leaky-grid detectors always come out wrong way up. This is no disadvantage.

This instrument will give, with a close coupling between L1 and L2 and an iron core well inserted, as much as 30 per cent frequency deviation. This will give an ample bandwidth even on the lowest frequencies, and more than enough at the modern television I.F.s of 30-40Mc/s.

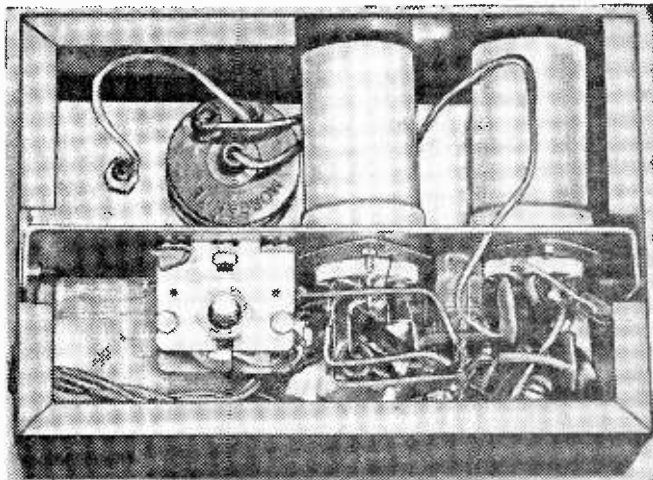

A view of the wiring.

**Modifications**

With certain EF50 valves, otherwise quite efficient, the gain-bandwidth product is not sufficient for the maintenance of oscillations above about 8Mc/s with the specified values of anode resistor, namely 680ohms and 1,000ohms. This situation becomes, worse if stray circuit capacitances become relatively large.

To ensure oscillation, the 1,000ohm resistance in V2 anode should be substituted by a small choke. An item which has proved satisfactory consists of 60 turns of 30s.w.g. enamelled copper wire, close-wound on a former 3/16in. in diameter.

It should be noted that an attempt to increase loop gain by increasing anode resistor values is of no use; it diminishes the frequency at which oscillation can be maintained. Beyond a certain point, multivibrator action begins, in which the tuned circuit in the cathode circuit of V1 plays a minor part; this is, of course, not the condition required.

**Choke**

The inductance of the choke should be such that together with the circuit capacitances of V2, its natural frequency of oscillation is much higher than that of the V1 cathode tuned circuit. If the inductance is 14μH the circuit capacitance 10pF, this condition is realised. However, if circuit capacitance is about 25pF resonance can occur in the V2 anode circuit at some setting of the tuning condenser, very large gain results and V1 is overloaded resulting in an effect similar to squegging. If in doubt therefore, it is better to reduce the size of the V2 anode choke.

<b>JOIN THE PRACTICAL GROUP</b>				
<b>PRACTICAL WIRELESS</b>	...	...	...	1/6
Every Month				
<b>PRACTICAL MECHANICS</b>	...	...	...	1/3
Every Month				
<b>PRACTICAL MOTORIST</b>	...	...	...	1/6
Every Month				
<b>PRACTICAL HOUSEHOLDER</b>	...	...	...	1/3
Every Month				

# A "Printed" Aerial Filter

A PRINTED CIRCUIT DESIGN FOR HOME CONSTRUCTION

By R.

**S**EVERAL kinds of interference commonly affect the reception of television pictures. They include the following, apart from ignition noise and mains-borne interference from brush-fed motors:

- Signals received at, or within, 3Mc/s of the intermediate frequency of the receiver,
- Signals received near the signal-frequency,
- "Image" signals from external sources,
- I.F. harmonics, produced at the detector, being fed back to earlier stages,
- Oscillator harmonics generated in the receiver itself.

## Elimination

Strictly speaking, there should be no difficulty in eliminating all these sources of interference. Good filtering and screening of the receiver itself is, in any case, necessary to remove the last two in the list—and perhaps decoupling more than screening. Reception via the aerial of interfering signals is dependent on several factors. One of the

more important is that no attempt is usually made to overcome the lack of "balance" that exists between aerial and coaxial feeder. As a result, the coaxial lead itself acts as an aerial and although it is very inefficient at picking up television frequencies, whether Band I or Band III, it is liable to receive a good deal of short-wave energy. Moreover, the lead comes down from the aerial through a region where—especially in towns—other television receivers are working and are generating as a rule a good deal of radiated energy.

While the use of suitably-proportioned balance-to-unbalance transformers ("baluns") could be used, it is normally much simpler to dispense with this complication and use other means of overcoming the trouble.

## Trap Circuits

If a single local source of radiation is the cause of "patterning" on the received picture, a common device is to include somewhere in the lead—and

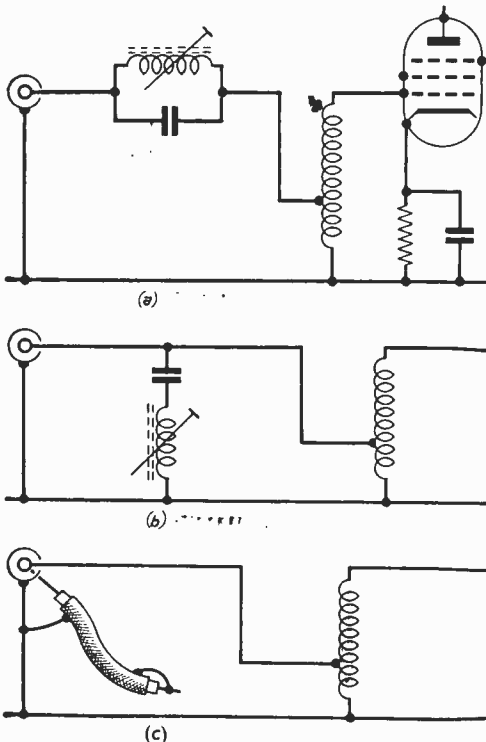
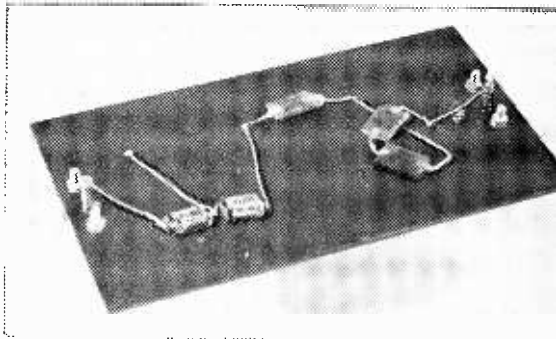

Fig. 1(a).—Rejector circuit.  
 (b).—Acceptor Circuit.  
 (c).—Short-circuited transmission line  
 (a special case of the acceptor circuit).



The reverse side of the printed board. The series/para combinations of condensers used to achieve the necessary values of capacity can be clearly seen.

as near as possible to the receiver—a simple trap circuit. Three possible arrangements are shown in Fig. 1.

Usually about 30dB attenuation of an interfering frequency is aimed at, and although the arrangements shown in Figs. 1(a) and (b) are sometimes used, only Fig. 1(c) will give this degree of attenuation in normal circumstances.

Where several different interfering frequencies may exist, none of these circuits is satisfactory. This is usually the case—the considerable bandwidth of the vision I.F. amplifier allows for many different frequencies to enter the amplifier. Under these conditions it is very difficult to remove unwanted frequencies by simple trap circuits, largely because the addition of extra traps affects those already fitted. The alignment is very tricky and the difficulty increases geometrically as the number of traps increases.

# Unit

Archer

## Printed Filter

The best method is the use of a suitable wave filter, and here is described the construction of such a filter using printed circuit techniques. The recent arrival on the "home experimenter" market of "do-it-yourself" printed circuit kits makes this feasible—although the amateur needs only to be able to obtain the copper-clad insulating board as the chemicals needed are freely obtainable and very cheap.

The wave filter is a combination of inductances and capacitances so chosen that, when inserted in a circuit between a generator and a load, very great attenuation of certain frequency bands occurs with negligible effects on other ranges of frequency. If the calculations have been successful, a very abrupt transition occurs between the wanted and unwanted frequencies.

## Matching

There are three types of filter in general use: the low-pass, the high-pass and the band-pass. Here

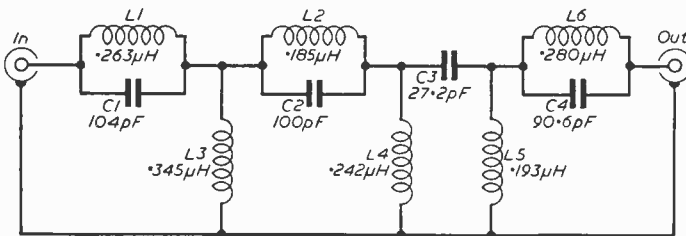
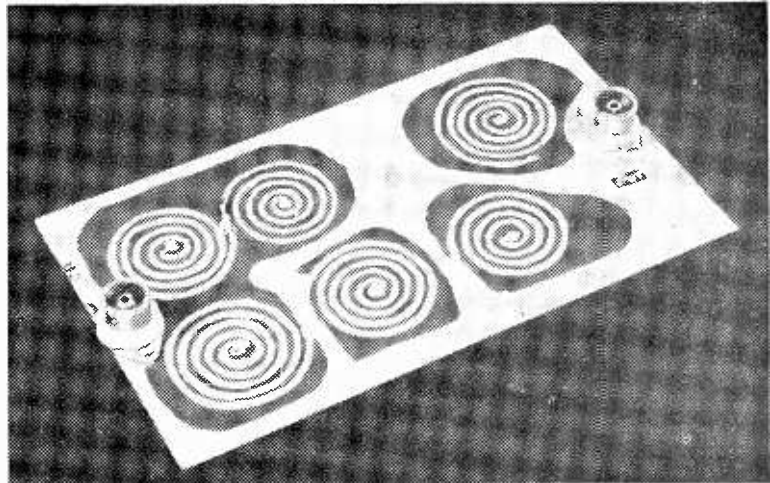

Fig. 2.—The theoretical circuit of the filter.

we are concerned with a high-pass filter — one which eliminates all frequencies below 41Mc/s and transmits, with little loss, all frequencies above this.

Any filter must be designed for definite input and output impedances. The filter described here is only suitable for inclusion in a coaxial line of 75Ω nominal impedance.

Wave filters normally incorporate both end sections and intermediate sections. The former are concerned chiefly with the achievement of the correct input and output impedances; the intermediate sections supplement the attenuation given by the end sections, allow for very great attenuation at certain frequencies, and ensure more uniform attenuation over the whole range.



The complete "printed" filter unit.

## "π" or "T" Types

Filters may be either π type or T type. This means, roughly, either of rejector or acceptor type. For this design, the π type has been chosen, because the self-capacitances of the coils affect the behaviour less, in that the condensers added in the design are in parallel with coil self capacitances. The theoretical circuit is shown in Fig. 2. Although one end is labelled, "In" and the other "Out" they are in fact interchangeable with no effect on performance.

Two possible methods of construction offer themselves as attractive alternatives. The printed circuit system has the advantage of simplicity of execution, a minimum of capacitance between input and output ends and reduction of coupling between the inductances. The alternative, of using coils wound on small formers, enables more accurate adjustment, especially of the very sharp edge of the transmission band. However, this makes alignment rather more difficult. For those who prefer not to use printed circuits, details of the

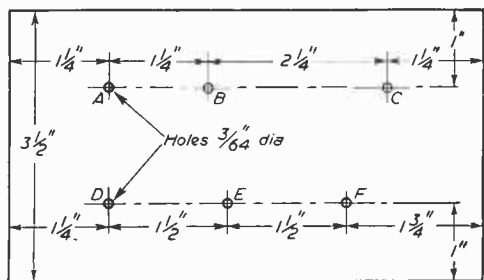

Fig. 3.—Marking out the board.

coils will be given and of an alignment method. It should be noted that in this case screening of the whole unit will probably be required.

### Construction

The copper-clad boards supplied with the 'do-it-yourself' kit measure about  $3\frac{1}{2}$  in. x 6 in. and this is a convenient size to use. The first thing to do is to clean the board with kitchen scouring powder, so that the copper is clean and bright. Then a line is drawn with a soft pencil 1 in. from each long edge of the board, right across it. Marking out and drilling is then completed as in Fig. 3.

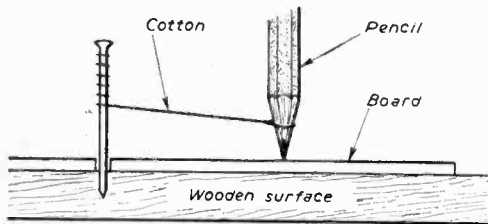

Fig. 4.—Marking out the coils.

A brass pin of normal size (1 in. long) is required, and it should be examined under a hand lens to ensure that its diameter is just a shade under  $1/32$  in. (i.e. 22s.w.g.).

A length of No. 40 Machine Twist is attached to this pin by a knot and is secured to the metal firmly with a touch of waterproof cement. When this is thoroughly dry the cotton is cut off to a length of about 2 in. and a small loop about  $\frac{1}{4}$  in. diameter is tied at the end, to take a pencil point.

### Marking the Coils

The copper-clad board, drilled with holes as shown in Fig. 3 is placed on a wooden surface. The pin with cotton attached is pushed through a hole into the wood so that it is firmly held. A soft (4B) pencil point is put through the prepared loop in the cotton and marking off the coil can begin. The idea is to keep the cotton uniformly tight while winding it on to the pin, meanwhile marking out the coil. The winding-up is done until the pencil point comes to within about  $\frac{1}{4}$  in. of the pin and the end of the coil is fashioned as shown in Fig. 5, so as to obtain a definite point where the coil begins. Counting from the centre the turns for each coil are as follows:—

Coil Centre	No. of Turns	Approximate maximum outer diameter
A	$4\frac{1}{2}$	0.65 in.
B	$4\frac{1}{2}$	0.6 in.
C	$4\frac{1}{2}$	0.675 in.
D	5	0.7 in.
E	$4\frac{1}{2}$	0.65 in.
F	4	0.6 in.

The figures for the outer diameter are given to afford a check on the dimensions of the spiral; if markedly more or less than this, a pin of different diameter or other cotton should be chosen.

### "Resist" Paint

When the spiral coils are marked in pencil they have to be covered with the 'resist ink', which consists of black cellulose paint. With care, and

the use of a fine brush, a steady enough line can be painted over the top of the pencil line already marked out. The thickness of the paint line is so arranged as to give, roughly, a spacing between turns equal to the width of the line, or a little over.

When dry, the paint line can be tidied up with the point of a penknife blade if any major inaccuracies have occurred in drawing. More of the copper is now covered with the cellulose paint so that not only is there sufficient copper left, after etching, to give low R.F. resistance to the 'chassis' but also some screening is afforded between coils. Reference to the illustration will indicate the sort of result to be achieved. It is advisable at this stage also to allow for holes to be etched to take coaxial sockets for input and output. The 'chassis' must not be brought too close to the coils.

### Cleaning

When the board is completely dry and the paint hard it should be washed thoroughly in hot detergent solution. Grease from the fingers may otherwise cause uneven etching. It is then placed in the etching solution, which is a strong solution of ferric chloride in water, and after about half an hour the copper not covered by the 'resist' will have been etched away.

The cellulose paint can now be scrubbed off with kitchen scouring powder. Cellulose 'thinners' are unnecessary for a small job like this, and are very dangerous if inhalation of the vapour occurs. For best results at this stage the remaining copper should be silver-plated. Methods of doing this have been published in PRACTICAL TELEVISION.

### Other Components

The capacitors used may be ceramic or silver-mica. The important thing is that they should be of 5 per cent. tolerance or better. Best results will be achieved if facilities exist for accurate capacitance measurement, when values can be selected from the constructor's stock to the nearest 1 per cent. The difficulty exists that the edge of the pass band is very close to the sound frequency of Channel 1, and so London viewers may find that some attenuation of 41.5 Mc/s occurs, unless care is taken in selecting capacitances. If this happens, C2 and C3 should be varied a little each way (say 3 to 5 pF) until the desired attenuation characteristic is achieved. The illustration of the reverse side of the unit shows how in the prototype series or parallel connection of capacitors is used—this was because higher accuracy was thus obtainable. The characteristic obtained with the prototype is shown in Fig. 6, and it will be seen from this that the usual I.F. range of 34.49 Mc/s is severely attenuated.

Even this filter gives no protection against 'image' (second-channel) interference which may occur by picking up the radiation from FM receiver oscillators. Only reasonably good selectivity ahead of the I.F. amplifier can prevent this. An interference signal within a megacycle or two of the desired signal is likewise not affected except that Channel 1 viewers see and hear no trace of signals below about 40 Mc/s.

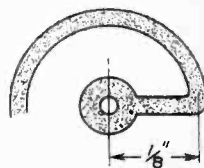

Fig. 5.—Details of the coil centres.



**The Filter using Conventional Coils**

For those who prefer to make up the unit using conventional coils, the following notes will be useful.

All coils except L3 (which has 4 turns) consist of 3½ turns of 30s.w.g. enamelled copper wire, close wound on a former ¼in. in diameter. A VHF type (purple-coded) iron dust slug is provided for each.

To set the coils to the required inductance by adjustment of the core, a 100pF capacitor (1 or 2 per cent accuracy) is placed across the probe terminals of a valve voltmeter. Using the shortest possible connector leads the valve voltmeter is attached across each inductance in turn. A signal generator is coupled very loosely indeed to each coil—the 'high output' terminal is best used if one is provided, and a short lead from it put 2 or 3in. away from the coil concerned.

The signal generator is set to the appropriate frequency, from the following table, and the core of the inductance in question is adjusted to resonance. This is repeated for each coil in turn, and on completion the

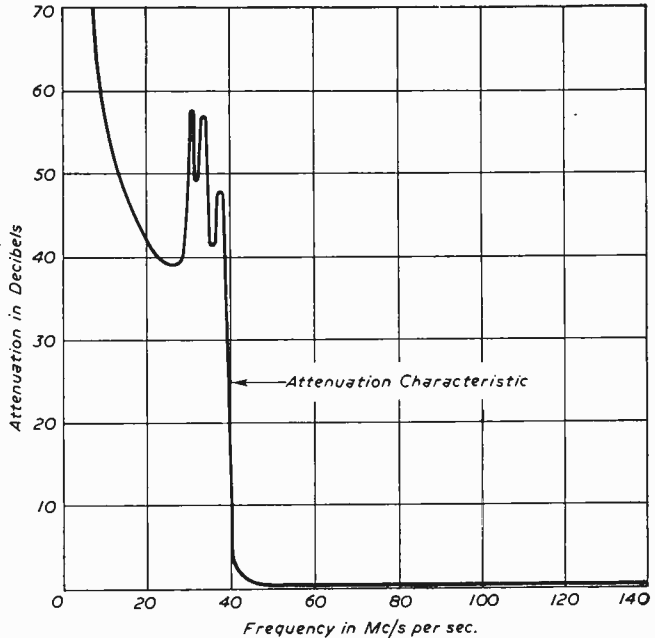

Fig. 6.—The attenuation characteristic of the filter.

**TABLE OF FREQUENCIES**

(loading capacitance of 100pF)

- L1 0.263μH—31.1Mc/s    L2 0.185μH—37.0Mc/s
- L3 0.345μH—27.0Mc/s    L4 0.242μH—32.2Mc/s
- L5 0.193μH—36.25Mc/s    L6 0.280μH—30.0Mc/s

unit is ready for use as soon as connections have been soldered up.

It should be noted that the filter must be connected as near as possible to the input socket of the receiver. Its efficiency if used properly is very great, but if a long length of coaxial cable joins the unit to the receiver unwanted signals can be picked up on this length and fed straight into the receiver.

**SERVICING TELEVISION RECEIVERS**

(Continued from page 400)

trimmers have a chassis contact, however, and extra connections should not be made until the circuit is checked.

**Fitting a Turret Tuner to Band I Models**

When it is desired to fit a tuner unit, the possibility of using V2 as an additional I.F. amplifier may be considered as this system bestows a useful extra gain which in some areas may be essential. The majority of tuners have a two-plug system; an R.F. plug to replace V1 and an I.F. plug or adaptor to replace V2. It is not difficult to rearrange the wiring so that all tuner connections are made to the R.F. plug, thereby enabling V2 to be retained. To do this, proceed as follows: disconnect V2 base pins 1 and 3 from chassis and connect a lead from these pins to the corresponding pins on the base of V1 (or take to chassis through

a 150Ω resistor shunted by a 0.005μF capacitor). Disconnect pins 2 and 8. Connect a 100Ω resistor from pin 2 to chassis (pin 6 or 9). Connect a 100k resistor from H.T. to pin 8 with a 0.005μF to chassis. Disconnect pin 7 of V1 base and wire a lead from this pin to pin 2 of the V2 base. Now rewire the R.F. plug as follows: H.T. to pin 8 (i.e. H.T. supply lead to tuner is derived from pin 8 of the R.F. plug); tuner heater leads to pins 4 and 5 removing the link if fitted; I.F. output (coaxial), inner to pin 7, outer to pin 6 or 9.

If a gain control lead is fitted (white) to pin 1 or 3 do not alter it but if pins 1 and 3 of V2 base have been connected to the corresponding pins of the V1 base, short the 82Ω resistors (2) to prevent feedback (these resistors are not decoupled).

The voltage (mains) adjustment carousel should be rotated to the next lower position to provide the extra heater current. The tuner requires 16V and as only V1 has been removed this leaves approximately 12V "to find".

# A Remote Controller

SIMPLE VOLUME AND MAINS CONTROL

By M. James

THIS remote controller was originally built for a television in the author's bedroom, where it was felt that a means was needed to control the sound level and "on/off" switch from the viewing position in bed. It could, however, be installed in any room and would greatly benefit cripples and the disabled.

### The Circuit

The volume control on most receivers is as shown in the diagram, with the signal level on the control grid of the valve being varied by means of a potentiometer, earthed at one end, and connected, via a condenser, to the anode of the preceding valve. The controller consists of a potentiometer of the same value as that in the receiver, connected (via the screened cable) in parallel with the original volume control, and a switch in series with the receiver on/off switch.

### Construction

First the volume and on/off control is located in the receiver, and the circuitry around the former checked to make sure it is as described above. An octal socket is then mounted at a suitable place on the back of the receiver, so that the remote controller can be detached when not required.

Two screened wires are then taken from points (a) and (b) to pins 1 and 3 on the socket, while the outer screening is connected to pin 2. Next, the mains wire is cut just before the switch, and wires are run from (d) and (e) to pins 6 and 7 respectively. From (f) and (g) wires are taken to pins 4 and 5.

To make the connection between the receiver and remote controller, any type of cable may be used, provided that the leads carrying any signal

are adequately screened. In the original, the author used a five core cable, with one lead screened and a length of television coaxial cable.

The appropriate connections are made with the cable to an octal plug, and it is better if a method of gripping the cable is employed to remove strain from the actual joints. Also the wires should be colour coded.

To house the combined volume on/off switch for the controller, a small aluminium container (originally purchased filled with tablets) measuring 2in. x 1½in. was used. This provided screening for the whole assembly and is easily held in the hand.

A fairly large hole is drilled, or cut in the bottom of the container and fitted with a rubber grommet to allow access for the cable, and the volume control is fitted in the centre of the lid. The wires are then brought in through the bottom, and connections are made to the potentiometer and switch; point (a) going to (a') etc., also a solder tag is bolted to the side of the container and a wire taken from it to the outer screening of the signal leads. Check the wiring, screw down the lid and seal it if necessary, and fit a knob to the shaft, and the controller is ready for use, after plugging in at the back of the receiver.

The on/off switch on the receiver should be in the "on" position, and the volume control at about its mid-point. The set can then be switched on, or off, and its volume varied from the viewing position.

If the receiver is of the A.C./D.C. type, where the chassis is connected to one side of the mains supply, it should be made certain before operating the controller, that the chassis is not live.

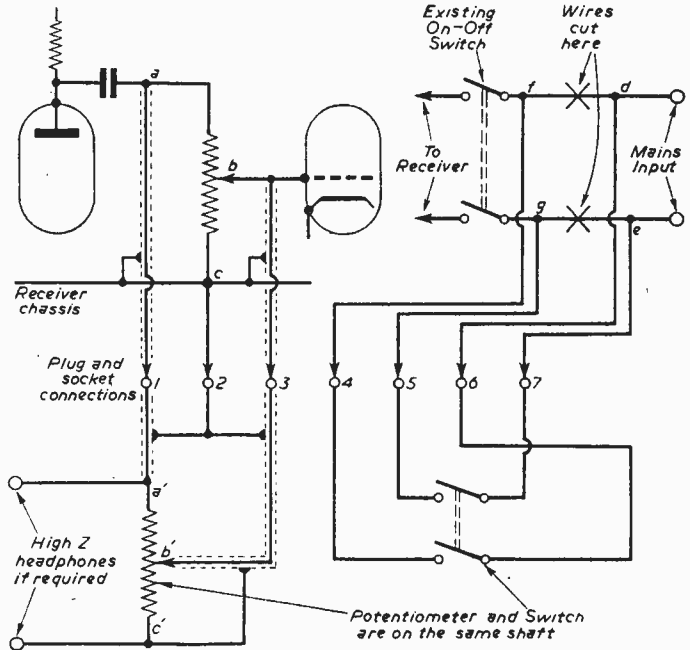

Fig. 1.—The circuit diagram.

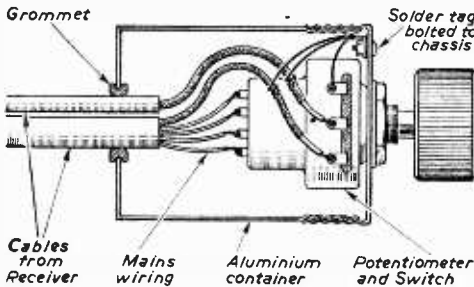
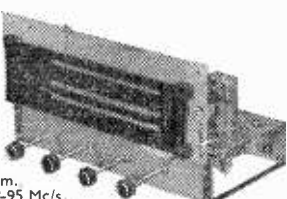

Fig. 2.—Constructional details.

## 7-VALVE AM/FM RADIOGRAM CHASSIS

**TR S**

Valve Line up:  
ECC85, ECH81,  
EF89, EABC80,  
EL84, EM81, EZ80.



3 waveband and switched gram positions. Med. 200 m.-500 m. Long 1,000 m.-2,000 m. VHF/FM 88-95 Mc/s.

4 Controls. Vol., On-off, Tone, Tuning, Wavechange. P.U., Ae. and E., and speaker sockets. Magic eye tuning. Philips continental tuning insert with permeability tuning on FM, and combined AM/FM IF transformers, 460 Kc/s and 10.7 Mc/s. Dust coat tuning all coils. Latest circuitry, including AVC and Neg. Feedback. 3 watt output. Sensitivity and reproduction of a very high standard. Chassis size 13 1/2 in. x 6 1/2 in. Height 7 1/2 in. Edge illuminated glass dial 1 1/2 in. x 3 1/2 in. Vertical pointer, Horizontal station names, gold on brown background. A.C. 200/250 v. operation.

**£13.10.0** Carr. and Ins. 5/- . Complete with 4 knobs walnut or ivory to choice

As previously announced fresh supplies are now being received, but we regret some slight delay may be experienced in fulfilling orders for this popular item.

### RE-GUNNED TV TUBES

#### New Reduced Prices!

And now 12 months' Guarantee!

12in. .... 26	17in. .... 28.10.0
14in. .... 27	21in. .... £10.10.0
15in. .... £7.10.0	Carr. and Insur. 10/-

All tubes Rebuilt with new Heater Cathode and Gun Assembly—reconditioned virtually as new! Fail 6 months' unconditional Guarantee. As used by our own Service Dept. Comprehensive stocks—quick delivery. 10/- part exchange allowances on your old tube.

### RECORD PLAYER CABINETS

Contemporary Cabinet styled, resin Price covered cabinet £3.3.0 in two-tone fawn and brown, Carr. and or mottled red Ins. 3/6. fitted with all accessories, including baffle board and anodised metal fret. Space available for all modern amplifiers and autochangers etc. Uncut record player mounting board 14 x 13in. supplied.



### 2-valve AMPLIFIER Mk.2

Latest developed circuit giving a higher fidelity response and greater output (2-3 watts) using twin stage valve ECL82 and neg. feedback Tone Control. Complete with knobs, etc., wired and tested ready to fit in above cabinet.

ONLY £2.17.6. P & P. 1/-.

6in. speaker and matching transformer, 22/-, P & P. 1/6.

**SENTERCEL RECTIFIERS.** E.H.T. Type Fly-back Voltages, K3/25 2 kv., 5/-; K3/40 3.2 kv., 6/9; K3/45 3.6 kv., 7/3; K3/50 4 kv., 7/8; K3/100 8 kv., 13/6. MAINS TYPES—RM1, 125 v. 50 mA. 4/8; RM2, 125 v. 100 mA., 5/8; RM3, 125 v. 120 mA., 7/8; RM4, 250v. 250 mA., 18/-; RM4B type 270 mA., 17/8; RM5, 250 v. 300 mA., 21/-.

**SPEAKER FRET.**—Expanded Bronze anodised metal 8 x 8in., 2/3; 12 x 8in., 3/-; 12 x 12in., 4/6; 12 x 15in., 6/-; 24 x 12in., 9/-, etc. Listed above are only a few items from our very large stock. Send 3d. stamp today for Complete Bargain List.

### FULLY GUARANTEED VALVES

NEW REDUCED PRICES	NEW REDUCED PRICES
1R5, 1T4 7/6; DAF96 9/-; EF80 9/6; PCF82 10/6	1R5, 1T4 7/6; DAF96 9/-; EF80 9/6; PCF82 10/6
1R5 8/6; DF96 9/-; EF86 13/6; PCL83 12/6	1R5 8/6; DF96 9/-; EF86 13/6; PCL83 12/6
384, 3V4 8/-; DK96 9/-; EL91 8/6; PL81 12/6	384, 3V4 8/-; DK96 9/-; EL91 8/6; PL81 12/6
5Z4 9/6; DL96 9/-; EL41 10/6; PL82 9/6	5Z4 9/6; DL96 9/-; EL41 10/6; PL82 9/6
6K7 5/6; EABC80 9/6; EL84 9/6; PL83 11/6	6K7 5/6; EABC80 9/6; EL84 9/6; PL83 11/6
6K8 8/6; EBC41 9/6; EM81 9/6; PY80 7/6	6K8 8/6; EBC41 9/6; EM81 9/6; PY80 7/6
6Q7 8/6; ECC83 9/6; EY51 10/-; PY81 9/6	6Q7 8/6; ECC83 9/6; EY51 10/-; PY81 9/6
6R8T 8/6; ECC84 10/6; EY86 10/-; PY82 7/6	6R8T 8/6; ECC84 10/6; EY86 10/-; PY82 7/6
6V6 7/6; ECF80 11/6; EZ80 7/6; PY83 10/6	6V6 7/6; ECF80 11/6; EZ80 7/6; PY83 10/6
6X4 7/6; ECF82 11/6; EZ81 7/6; U23 12/6	6X4 7/6; ECF82 11/6; EZ81 7/6; U23 12/6
7C5 9/-; ECH81 10/6; M114 9/6; 1R1 12/6	7C5 9/-; ECH81 10/6; M114 9/6; 1R1 12/6
7Y4 8/6; ECL80 10/6; PCC84 10/6; UCH42 10/6	7Y4 8/6; ECL80 10/6; PCC84 10/6; UCH42 10/6
35L6 9/6; ECL82 11/6; PCF80 10/6; U6A 10/-	35L6 9/6; ECL82 11/6; PCF80 10/6; U6A 10/-

Send for List of more Valve Bargains.

### SPECIAL PRICE PER SET

1R5, 1T4, 1R5, 384 or 3V4 .. .. .	27/6
DK96, DF96, DAF96, DL96 .. .. .	35/-
6K8, 6K7, 6Q7, 6V6, 5Z4 or 6X5 .. .. .	35/-

### COAX 80 OHM CABLE.

Stand 1/2 in. diam. Low Loss Semi-Air Spaced Aeraxial. Top grade cable—not to be confused with in/air types

#### SPECIAL REDUCED PRICES

20 yds. 12/6. p. & p. 1/6; 40 yds. 22/6. p. & p. 3/-; 40 yds. 22/6. p. & p. 3/6; All other lengths 8d. per yard  
Coax Plugs 1/-, Sockets 1/-, Couplers 1/8, Cable End Sockets 1/8, Outlet Boxes 4/8.

### TRANSISTOR 'ONE-WATT' AMPLIFIER

6 v. Battery operated

Latest Push-Pull, 4 Transistor circuit giving full 1 watt Output into standard 3 ohm speaker. Good sensitivity and improved freq. response. Neg. feedback. Var. Tone and Volume Controls. Chassis Size 6 1/2 in. x 3 1/2 in. x 1 1/2 in. Current consumption 10 mA quiescent—250 mA at 1 watt. 2 matched GEC GRT15 Transistors. 42/- pr. 2 GEC GRT5 Transistors.....21/- pr. Driver Trans..... 8/6 Output Trans. (to 3 ohms).....10/8 Complete Kit of Parts incl. circuit etc. less speaker. ONLY 99/6 P. & P. 2/6.

Circuit and instruction booklet 1/6 post free.

### VOLUME CONTROLS

30,000 ohms—2 Megohms. All long spindles. Morganite Midget type, 1 1/2 in. diameter. Guar. 1 year. Log or Lin. Ratios. Less Sw. 3/-. D.P. Sw. 4/9. Twin Ganged controls, 2 meg., 1 meg., 1 meg., less Sw. 8/9 ea.



### BAND 3 TV CONVERTER

All channels 7-13 (180-205 Mc/s). Mk. 2 Model. Latest cascade circuit using ECC84 and EF80 valves. 18db gain over standard circuits. Built-in Power Supply 200-250 v. A.C. Size 6 1/2 in. x 3 in. x 4 in. Simple to fit—only external plug-in connections. Wired and aligned ready to use. Only 7/9, P. & P. 2/6.  
B1-B3 changeover Sw. and BBC Aerial Socket fitted and wired, 8/- extra.  
Band 3 Aerials. Single Dipole with 4 yds. cable, 13/9. 3 Element Beam, 25/-, 5 Element, 32/8, etc. B1-B3 Crossover Units, 7/6.

### RECORD PLAYER BARGAINS

NEW RELEASE by E.M.I.—4-speed Single Player Unit fitted with latest stereo and monaural Xtal cartridge and dual sapphire styli. Auto stop and start. A fidelity unit and bargain buy at only £18.18.

BSR—UA8 Model. 4-speed autochanger with crystal turnover cartridge, etc., wired for stereo. Bargain £6.19.6.

Garrard—Latest RC121D/Mk. 2—fitted with GC8 Xtal cartridge, plug-in monaural head. Auto/manual selector, etc. The connoisseur's choice for audio perfection. Bargain 10 gns.  
Plug-in stereo head GCS/10 £2 extra.

All above are brand new, fully guaranteed models. Carr. and Ins. 4/6.  
Comprehensive bargain range of Collaro, BSR and Garrard Units in stock. Send for comprehensive bargain lists.

### G.R.T. Heater

### Isolation Transformers

New Improved types—mains prim. 200/250 v. tapped.

All isolation Transformers now supplied with alternative no boost plus 25%, and plus 50% boost taps, at no extra charge.  
2 v. 2A type 12/6 (P. & P. 1/6)  
6.3 v. 3A .. 12/6 ..  
10.5 v. 3A .. 12/6 ..  
13 v. 3A .. 12/6 ..  
Other voltages available at same prices.  
Small size and tag terminated for easy fitting.

### JASON FM TUNER UNITS

(87-105 Mc/s)

Designer-approved kits of parts for these quality and highly popular tuners available as follows:

**STANDARD MODEL (FMT)**—as previously extensively advertised. COMPLETE KIT, 5 gns. post free. Set of 4 spec. valves, 30/-, post free.

**LATEST MODEL (FMT2)**—attractively presented shelf mounting unit to enclosed Metal Cabinet with Built-in Power Supply. COMPLETE KIT, £7, p. & p. 3/6. Set of 5 spec. valves 39/6.

**NEW JASON COMPREHENSIVE F.M. HANDBOOK**, 2/6 post free. 48 hr. Alignment Service, 7/6. p. & p. 3/6.

**TYGAN FRET** (Murphy pattern) 12 x 12in., 2/-; 12 x 18in., 3/-; 12 x 24in., 4/-, etc.

**SPEAKERS P.M.** 3 ohm 2 1/2 in. Elac, 16/8. 3 1/2 in. Goodmans, 18/6. 5in. R. & A., 17/8. 6in. Celestion 18/6. 7 x 4in. Goodmans, 18/6. 8in. Rola, 20/-, 8in. Special Cone G'mans, 21/6. 10in. R. & A., 26/-.

Terms: C.W.O. or C.O.D. Kindly make cheques, P.O.s etc., payable to T.R.S. Post/Packing up to 1/6. 7d. 1/1, 3/6. 1/6, 5/6. 2/-, 10/6. 2/9 Hours: 9 a.m.-6 p.m. 1 p.m. Wed. Open all day Saturday.

**TR S**

## RADIO COMPONENT SPECIALISTS (Est. 1946)

70 BRIGSTOCK ROAD, THORNTON HEATH, SURREY (THO 2188)

50 yards Thornton Heath Station.

Buses: 130A, 133, 159, 166 and 190

# Let I.C.S. train YOU!



**COURSES ON:—**

- **RADIO and TELEVISION SERVICING**
  - **ELECTRONICS**
- EXAMINATION COURSES FOR:—**

**C. & G. Radio Servicing Certificate**  
(R.T.E.B.)

**C. & G. Radio Amateurs' Exam.**  
(Amateurs' Transmitting Licence)

**British Institution of Radio Engrs., etc.**

Whether you plan to have your own business, to become an electronics engineer or to take up a career in industry, an I.C.S. Course will help you to succeed. You learn at home in your own time, under expert tuition. Moderate fees include all books.

## LEARN - AS - YOU - BUILD

### Practical Radio Course

- A basic course in radio, electronic and electrical theory backed by thorough practical training. You build a 4-valve T.R.F. and a 5-valve superhet radio receiver, signal generator and multi-tester.
- Other Learn-as-you-Build radio courses are available

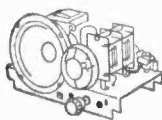

**MULTI-TESTER**  
(Sensitivity 1,000 ohms per volt)

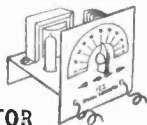

**5-VALVE SUPERHET RECEIVER**

**RF/AF SIGNAL GENERATOR**

**Post this Coupon TODAY!** for FREE book on careers in Radio, etc., and full details of I.C.S. Courses.

**International Correspondence Schools**  
(Dept. 164B), Intertext House, Parkgate Road, London, S.W.11.

Please send book on \_\_\_\_\_

Name \_\_\_\_\_ Age \_\_\_\_\_  
(Block Letters please)

Address \_\_\_\_\_

Occupation \_\_\_\_\_ 5-60

**INTERNATIONAL CORRESPONDENCE SCHOOLS**

## Multi-Purpose VALVE FILAMENT TESTER Model VT41

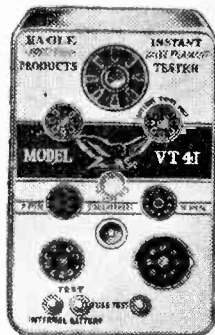

- Pocket size
  - Battery operated
- GIVES INSTANT CHECK OF:**
- ★ All TV and Radio Valves and Fuses.
  - ★ All pilot lamps.
  - ★ Circuit Continuity.
  - ★ Built-in 7 and 9 pin valve straighteners.
  - ★ Built-in Battery Test.

Finished in black hammer case with gold front panel. Complete with internal batteries, full instructions and ready for use.

With this revolutionary instrument you can test all current Valves, Fuses, Continuity and other radio parts. All components tested are shown "good" or "faulty" on panel indicator.

**30/-**

From your local dealer or if in difficulty order direct:

**EAGLE PRODUCTS** (Dept. P.T.2.)  
**EAGLE WORKS, COPTIC ST., LONDON, W.C.1.**



**TOP QUALITY AT UNAPPROACHABLE PRICES**

With 12 Months Full Guarantee

## NEW GUN TV TUBES

\*This means Completely New Gun Assembly with New Button and Base. Rescreened and Realumined. **VIRTUALLY A NEW TUBE.** All Mullard and Mazda and Hardglass Types.

12"-14"	-	-	£6.0.0
15"-17"	-	-	£6.10.0
21"	-	-	£9.0.0

Electrostatic Focus 10/- extra.  
Trade enquiries welcomed.

All carriage and insurance now paid by us, to your address and on return of old tube all by passenger train, inclusive at £1 extra. All C.W.O. Old tubes must be returned to us, or an extra charge of 10/- will be made on 12 to 17in. tubes.

**SABRINA C.R.T. COMPANY**  
"ELECTRON WORKS," NORTH BAR  
BANBURY, Oxon. Phone 2390.

# Measuring Low Resistance

PRINCIPLES AND PRACTICAL CIRCUITS

By J. S. Kendall

THE measurement of values of resistance of the order of  $1\Omega$  with any degree of accuracy is a problem unless special instruments are available. Stray resistance becomes very important—for example a pair of leads can measure  $0.01\Omega$ . This resistance can be neglected when making measurements of the order of  $10\Omega$  but  $0.01\Omega$  is 1 per cent of  $1\Omega$  and 10 per cent of  $0.1\Omega$  and therefore when making measurements of very low resistance the error introduced by lead resistance may not be neglected. In fact, it may be necessary to deduct the lead resistance from the final reading.

**Principles**

A basic method of measuring the resistance of a coil is shown in Fig. 1.  $R_s$  is a known standard resistor and  $R_x$  is the unknown resistor. The circuit therefore is of the simple series type with the same current flowing through  $R_s$ ,  $R_x$  and  $R_i$  which represents the internal resistance of the battery.

Let the current in the circuit be  $I_a$ . Therefore applying Ohm's Law to  $R_s$ .

$$I = E_{rs}/R_s$$

where  $E_{rs}$  is the P.D. across  $R_s$ .

Applying Ohms Law to  $R_x$ ,

$$I = E_{rx}/R_x$$

where  $E_{rx}$  is the P.D. across  $R_x$

Therefore  $E_{rs}/R_s = E_{rx}/R_x$

$$\text{Therefore } R_x = R_s \times \frac{E_{rx}}{E_{rs}}$$

For clarity, suppose a coil were being measured. The standard resistance used is  $3\Omega$ , the voltage across the standard is 2.1 and that across the coil is 0.8. Then from the formula given above

$$R_x = \frac{3 \times 0.8}{2.1} = \frac{24}{21} = 1 \frac{1}{7}$$

We must now determine the accuracy of the reading. If the lead joining the standard resistance to the coil were included in the circuit across which the voltage drops were measured, then the reading will be inaccurate. The accuracy of the standard resistor must also be considered; it may be a 1 per cent type which means that its actual value is within  $\pm 1$  per cent of the value printed on it. The meter reading may be within  $\pm 3$  per cent. These errors may be considered negligible, but if the resistor was, say, a 5 per cent type the total error might be as much as  $\pm 8$  per cent. For coils and the like, a reading correct within 10 per cent is adequate but, on the other hand, if the resistor was intended for use as a shunt on a meter, a more accurate reading would have to be made. Two or three sets of different readings could be taken with different standards,

each as accurate as possible, and the arithmetical mean or average value calculated.

**Parts**

After considering the basic principles involved in the measurement of low resistance, we may now consider the design of a suitable unit. Three good quality parts are required, which should not be obtained from the junk box: a set of three standard resistors (1, 3 and  $10\Omega$ ); the wafer switch, which must have a very low, and constant, contact resistance and the terminals. It is likely that a double-pole, double-throw toggle switch of good quality is available, but it should be checked that the contact resistance is low and does not vary at all. The terminals are difficult to clean but when once in use will maintain a low contact resistance to the wires but only as long as they are not moved. New terminals have low resistance and therefore require no cleaning before use.

The mounting of the parts can be left to the constructor, and most parts can be fixed to a suitable panel, the material of which is not at all critical. The toggle switch should have solder tags, not terminals, and then the three standard resistors can be wired between the tags of the wafer switch and the appropriate tag of the toggle switch. The lead from the battery is also taken direct to this same solder tag. The housing can be made to suit the panel or the panel to suit the housing. A suitable container may be made from a cigar box, if available, or a metal box.

For general use, the resistors can be 1, 3 and  $10\Omega$ . Other values can be chosen, but it is not

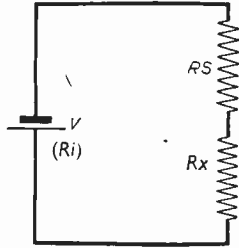

Fig. 1.—Series circuit.

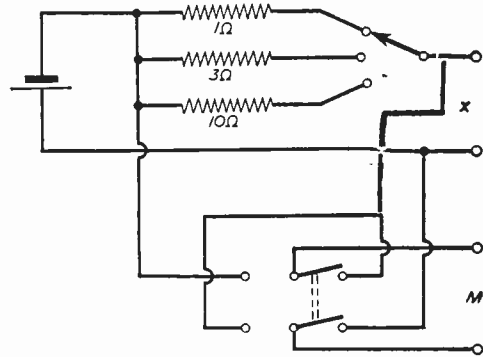

Fig. 2.—A practical circuit.

recommended that a standard of more than  $100\Omega$  be used, in which case a set of five standards is recommended: 1, 3, 10, 30 and  $100\Omega$ . The tolerance should be 1 per cent.

**Lead Resistance**

Lead errors should be taken into consideration if necessary. The resistance may be measured

directly by shorting the leads together at their far end and the value measured may be deducted from the final measurement.

If a direct reading meter is preferred, a simple unit may be constructed, provided that a sensitive meter of 1mA f.s.d. is available (or any meter of  $10\Omega$  or higher internal resistance with an f.s.d. of 0.1mA or lower). For example, of a 10mA meter of exactly  $10\Omega$  resistance were available, this would be suitable but the  $10\Omega$  scale resistor (Fig. 4) would not be required. Again, a 10mA meter that could be made up to  $10\Omega$  would be suitable. On the other hand, matters would be simplified considerably if a meter of  $100\Omega$  and 1mA f.s.d. were available and it would be possible to obtain a more accurate overall standard for the  $1\Omega$  range. Of course, a 0.1mA meter of  $1,000\Omega$  would be even better—and more costly.

If a  $10\Omega$  meter were used a  $1:10$  resistor would have to be obtained for the  $1\Omega$  range. Such a value is more difficult to obtain than a  $1\Omega$  standard. The parts of these meters are specialised but generally dealers are willing to order them or they may be purchased direct by post.

### Final Circuit

In the circuit in Fig. 3, as in the circuit in Fig. 1, the current throughout the circuit is the same, but the total meter deflection will depend on the setting of the variable resistor  $R_v$ . In use, this is adjusted so that the meter reads full scale deflection. Any resistor which is then placed across the "unknown" terminals is then in parallel with the meter and will shunt away part of the current, e.g. if the standard resistance is  $10\Omega$  and a  $10\Omega$  resistor is placed in circuit across the terminals, then the meter reading will drop by a half. A meter having a long scale may be calibrated to give more readings than a small one but it is not recommended that too many points be drawn on the scale or it will be too crowded. Values between

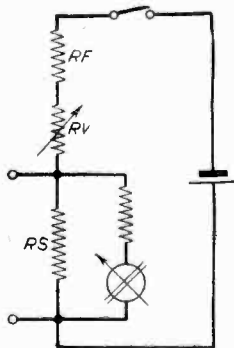

Fig. 3.—Principle of "shunt" type meter.

$1\Omega$  resistor in parallel. If the meter is of  $10\Omega$ , then the resistance for the  $10\Omega$  range would have to be ignored. Again with a meter of  $100\Omega$ , the standard in parallel for the  $10\Omega$  range would be  $11\Omega$  and for the  $1\Omega$  range the error owing to the meter could be ignored as it would not exceed 1 per cent.

Do not be tempted to calibrate to a very high accuracy—1 per cent deflection is  $1/1000$  of the

standard; 9 per cent is  $1/10$ ; 91 per cent is ten times and 99 per cent is 100 times. If possible should be used for calibration. It is best to calibrate the higher scale and assume that the lower would follow the same markings.

### Batteries

The instrument will draw a maximum current of some 100mA so that the batteries do not need to be large in capacity. The voltage should be about  $4\frac{1}{2}$  although a 6V battery may be used to allow for a deterioration of 2V which may be eliminated

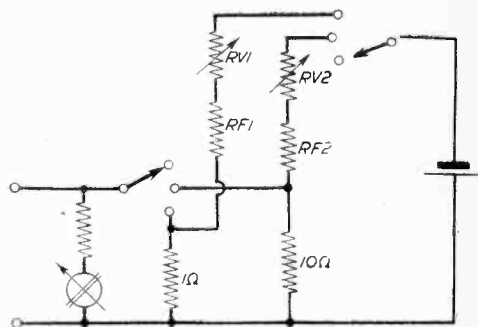

Fig. 4.—Final circuit developed from Fig. 3.

by the use of  $R_{v1}$  and  $R_{v2}$ . For the  $1\Omega$  range a  $20\Omega$  variable may be used, and for the  $10\Omega$  range a variable of about  $200\Omega$ . These values are not critical and even values of  $50\Omega$  and  $500\Omega$  would be suitable. The remainder of the required resistance is made up by the fixed resistors  $R_{f1}$  and  $R_{f2}$  which should be calculated to be about 20 per cent higher than the resistance which is required with the full  $20\Omega$  or  $200\Omega$  in circuit. Never rely on the variable resistance alone for the full resistance of the circuit or the meter may be burnt out when adjustments are made. When a 4.5V battery is used the values would be  $30\Omega$  and  $300\Omega$ ; for a 6V battery  $50\Omega$  and  $500\Omega$  would serve. For convenience of purchase, preferred values must be used and not those calculated. Thus, resistors of  $33\Omega$  and  $330\Omega$  for the 4.5V battery ( $47\Omega$  or  $470\Omega$  for 6V) would be required with a tolerance of 20 or 10 per cent. The resistor should have a rating of 2W to avoid drift in resistance value while the meter is being used.

The lead resistance may have to be taken into account and can be measured direct by shorting the leads together and the value deducted from a total resistance reading.

## PRACTICAL TELEVISION CIRCUITS

288 pages - - - 156 Illustrations

15/- net or 16/1 by post from

**GEORGE NEWNES LTD.**

Tower House, Southampton Street  
London, W.C.2

**LOTS & LOTS of**  **TINKERS, TAILORS, \*  
SOLDIERS, SAILORS,  
AIRMEN, APPRENTICES & Ordinary Chaps  
like You and Me . . . . . Are Learning  
BASIC ELECTRICITY & BASIC ELECTRONICS  
THIS NEW 'PICTURE BOOK' WAY  
Why don't you too?**

Now available to Civilian Readers, in eleven illustrated Manuals, is this NEW-STYLE Training Course, developed for the U.S. Navy by the New York firm of Management Consultants, VAN VALKENBURGH, NOOGER & NEVILLE, INC., and adapted to British usage by a special team investigating the most modern methods of teaching Electricity and Electronics at Training HQ of the Royal Electrical and Mechanical Engineers.

IT HAS ALREADY BEEN ADOPTED for Training by:—REME—Royal Signals—Technical Training Command, RAF—N.Z. and S. African Air Forces—Army of Pakistan—National Cash Register Co.—Richard Thomas & Baldwins—Uganda Electricity Board—Addressograph-Multigraph—Mullard.

\* To be honest, we're not yet 100% sure of either the Tinkers or the Tailors. But there's no shadow of doubt that they all could learn Electricity and Electronics this wonderfully simple "PICTURE-BOOK WAY" if they wanted to!

**COUPON - SEND NOW!**

To THE TECHNICAL PRESS LTD.  
1 Justice Walk, Lawrence St., London S.W.3.

Please send me your FREE prospectus, describing 'BASIC ELECTRICITY' and 'BASIC ELECTRONICS'

NAME .....

ADDRESS .....

.....

# R.S.C. (BRADFORD, LEEDS) (and MANCHESTER)

(Leeds) Ltd.

Post Terms C.W.O. or C.O.D. No C.O.D. under £1. Postage 1/9 extra under £2. 2/9 under £5. Open to callers 9 a.m. to 6 p.m. Wednesdays until 1 p.m. S.A.E. with enquiries, please. Trade supplied.

## R.S.C. TRANSFORMERS

Fully Guaranteed  
Interleaved and Impregnated  
Primaries 200-230-250 v 50 c/s screened  
**TOP SHROUDED DROP THROUGH**  
260-0-260 v 70 ma, 6.3 v 2 a, 5 v 2 a .. 17/9  
350-0-350 v 80 ma, 6.3 v 2 a, 5 v 2 a .. 18/9  
250-0-250 v 100 ma, 6.3 v 4 a, 5 v 3 a .. 25/9  
300-0-300 v 100 ma, 6.3 v 4 a, 5 v 3 a .. 23/9  
350-0-350 v 100 ma, 6.3 v 4 a, 5 v 3 a .. 23/9  
350-0-350 v 150 ma, 6.3 v 4 a, 5 v 3 a .. 29/9

**FULLY SHROUDED UPRIGHT**  
250-0-250 v 60 ma, 6.3 v 2 a, 5 v 2 a .. 17/9  
Midget type 21-3-3 in. .. 17/9  
250-0-250 v 100 ma, 6.3 v 4 a, 5 v 3 a .. 25/9  
300-0-300 v 100 ma, 6.3 v 4 a, 5 v 3 a .. 27/9  
350-0-350 v 100 ma, 6.3 v 4 a, 5 v 3 a .. 27/9  
350-0-350 v 150 ma, 6.3 v 4 a, 5 v 3 a .. 35/9  
425-0-425 v 200 ma, 6.3 v 4 a, C.T. .. 42/9  
6.3 v 4 a, C.T. 5 v 3 a .. 49/9

**FILAMENT TRANSFORMERS**  
All with 200-250 v 50 c/s Primaries: 6.3 v, 1.5 a, 5/9; 6.3 v 2 a, 7/6; 4-4-6.3 v 2 a, 7/9; 12 v 1 a, 7/11; 6.3 v 3 a, 8/11; 6.3 v 6 a, 17/9.

**CHARGER TRANSFORMERS**  
200-250 v 0-9-15v 11 a, 12/9; 0-9-15 v 3 a, 16/9; 0-9-15 v 5 a, 18/9; 0-9-15 v 6 a, 23/9.

**OUTPUT TRANSFORMERS**  
Midget Battery Pentode 66.1 .. 3/9  
Standard Pentode 5,000 to 3 ohms .. 3/9  
Small Pentode 5,000 to 3 ohms .. 5/9  
Standard Pentode, 7/8,000 to 3 ohms 5/9  
Push-Pull EL84 to 3 or 15 ohms 18/9  
Push-Pull 10-12 watts 6V6 to 3 or 15 ohms .. 18/9  
Push-Pull 10-12 watts 6V6 to 3, 5, 8 or 15 ohms .. 19/9

**SMOOTHING CHOKES**  
100 ma 10 h 250 ohms .. 8/9  
80 ma 10 h 350 ohms .. 5/6  
60 ma 10 h 400 ohms .. 4/11

**SELENIUM METAL RECTIFIERS**  
Special quotes for quantities of 50 to 5,000.  
**H.T. (H.W.)**  
250 v 50 ma .. 3/11  
250 v 80 ma .. 5/11  
250 v 100 ma .. 6/11  
250 v 100 ma .. 6/11  
250 v 100 ma .. 6/11  
250 v 80 ma .. 6/11  
250 v 75 ma .. 6/11  
F.W. (Bridge) 8/11  
6/12 v 1 a .. 8/11  
6/12 v 2 a .. 3/11  
6/12 v 3 a .. 9/9  
6/12 v 4 a .. 12/3  
6/12 v 5 a .. 14/6  
6/12 v 6 a .. 15/6  
6/12 v 10 a .. 25/9  
6/12 v 15 a .. 27/9

**CO-AXIAL CABLE** 1/4 in.  
75 ohms 14/36 .. 8d. yd.  
Twin-screened Feeder .. 11d. yd.

**BATTERY SET CONVERTER KIT**  
All parts for converting any normal type of Battery Receiver to A.C. mains 200-250v 50 c/s. Supplies 120 v, 90 v or 60 v or 40 ma, fully smoothed and fully smoothed L.T. of 2 v at 0.4 to 1 a. Price including circuit, 49/9. Or ready for use, 9/9 extra.

**ALL DRY RECEIVER BATTERY ELIMINATOR KIT**—All parts for the construction of a unit (metal-case 51-41-2in.) to supply Battery Portable receivers requiring 50 v and 1.5 v. Fully smoothed. From 200-250 v 50 c/s mains. Price, inc. point-to-point wiring diagrams, 39/9. Or ready for use, 46/9.

**D.C. SUPPLY KIT**—Suitable for Electric Trains. Consists of mains trans. 200-250 v 50 c.p.s. A.C. 12 v 1 a Selenium F.W. Bridge Rectifier, 2 Fuseholders, 2 Selector Change Direction Switch, Variable Speed Regulator. Partially drilled Steel Case. and Circuit. 33/9

**TELEVISION RECTIFIERS**  
250 v 200 ma. Size 3 x 1 1/2 in. Brand New, 6/8.

## EX-GOVT. MAINS TRANSFORMERS

All 200-250 v 50 c/s input  
Removed from New ex-Govt. units, 22/9  
270-0-275 v 100 ma, 6.3 v 7 a, 5 v 3 a .. 11/9  
300-0-300 v 80 ma, 6.3 v 2 a .. 11/9  
265-0-265 v 150 ma, 6.3 v 11 a, 5 v 3 a, 5 v 3 a .. 29/11  
350-0-350 v 100 ma, 6.3 v 2 a, 5 v 2 a .. 18/9  
0-10-25 v 24 a. .. 79/6, carr. 15/-

**AUTO 0-110/120-220/240 v, 50 watts .. 8/11**

**EX-GOVT. SMOOTHING CHOKES** .. 2/11  
60 ma 5-10 h 250 ohms .. 6/9  
80 ma 10 h 150 ohms .. 3/11  
100 ma 5 h 100 ohms Tropicalised .. 6/9  
100 ma 8-10 h 100 ohms Parmeko .. 8/9  
150 ma 12 h 100 ohms .. 8/9  
150 ma 10 h 150 ohms .. 8/9  
200 ma 3-5 h 100 ohms Parmeko .. 7/9

**EX-GOVT. CASES.** Well ventilated, black crackle finished, undrilled cover. Size 14 x 10 x 8 1/2 in. high. IDEAL FOR BATTERY CHARGERS OR INSTRUMENT CASE. OR COVER COULD BE USED FOR AMPLIFIER. Only 9/9. Plus 2/9 postage.

## BATTERY CHARGERS

For 200/250 v 50 c/s A.C. mains. 12 months guarantee. Attractive, well ventilated hammer finished cases, 6 v or 12 v 4 amp. with meter and variable charge rate selector, as illustrated 69/9  
Or Deposit 13/3 and 5 monthly payments of 13/3. 6 v or 12 v 1 amp type. Also suitable for electric train power supply. Only 29/9 post 2/9.



## RST MAIL ORDER DEPARTMENT

211 Streatham Road, Mitcham, Surrey  
ALL VALVES LISTED ARE NEW STOCK  
\*Terms C.W.O. or C.O.D. Postage 3d. per valve.  
MITCHAM 6201.

AZ31 10/6	EF92 5/-	PCF82	UY35 7/6	6K8G 7/6
B65 9/6	EL42 10/-	PCL82 11/6	VP4B 17/6	6K8GT
DAF91 7/6	EL94 7/-	PCL83 11/6	W81M 5/9	6L1 12/6
DF91 5/6	EL90 9/6	PCL83 11/6	W142 9/-	6L6G 7/6
DH719 7/6	EM80 10/6	PENA4 12/-	W727 7/6	6L18 12/6
DK91 9/-	EY81 10/6	PENA4 17/6	X78 21/-	6L19 21/-
EABC80	EY84 10/6	PENA4V4 17/6	X79 21/-	6N7G/1
EA4210/-	EY86 9/6	PL36 15/-	Z21 12/6	6SL7G 7/8
EB91 5/-	EY91 9/-	PL36 15/-	Z77 5/-	6SL7G 6/8
EB41 9/6	EZ35 7/6	PL81 14/9	Z152 7/6	6SN7GT
EBF80 9/6	EZ40 7/6	PL82 8/-	Z179 7/6	6V6G 5/6
EBF89 9/-	EZ41 7/6	PL83 10/6	1R5 9/-	6X5GT 5/6
EC91 9/6	EZ80 7/6	PL83 10/6	5V4G 7/-	7S7 10/6
ECC33 8/-	EZ81 7/6	PY30 8/6	5V4GT 8/6	7Y4 7/8
ECC81 8/-	FC2 21/-	PY81 7/6	5Z4G 10/-	8D3 5/6
ECC83 9/6	FC4 17/6	PY82 8/-	6AG8T 10/-	10LC11 15/-
ECC84 9/6	FC13 17/6	RY21 8/6	6AL5 5/-	12AH8 10/-
ECC85 9/6	FC30 21/-	R10 21/-	6AM6 5/6	12AT6 9/-
ECC89 9/6	GZ32 11/6	R19 19/6	6AN5 7/6	12AT7 8/-
ECF80	H30 5/6	TDD4 17/6	6AQ5 8/6	12AU7 9/-
ECF82 12/6	H63 9/6	TP22 17/6	6BA5 7/6	12AX7 8/-
ECF83 12/6	HBC90 9/6	U142 8/-	6BB6 7/6	12BA6 9/-
ECH35 9/-	HL92 9/6	U147 7/-	6BQ6 7/6	12BE6 9/6
ECH4210/-	HL33D 10/-	U153 9/6	6BR7 15/-	12BH7 15/-
ECH81 9/-	KT33C 10/-	UABC80 8/-	6BWT 8/6	12J7G/GT 9/6
ECL80	KT66 10/-	UAF42 9/6	6BX6 6/8	12K7GT 8/6
ECL82 9/-	LK219 12/6	UBC41 9/6	6D2 5/-	12K8GT 8/6
EF37A 8/6	MKT4(5) 12/6	UBF80 9/6	6F1 15/6	12Q7 12/6
EF40 15/-	(OF 7) 17/6	UCH42 9/-	6F12 5/-	12Q7GT 8/6
EF41 9/6	ML4 15/6	UCH81 9/-	6F18 17/6	35Z4GT 8/6
EF42 10/6	MSP4 17/6	UCL83 9/-	6G9G 7/6	50L6GT 7/6
EF50(A) 4/6	MU14 9/6	UF41 9/-	6K7 4/6	6K7GT 4/6
EF90 7/-	N14 9/6	UF41 9/-	6K7G 4/6	6K7GT 9/-
EF95 7/-	N153 11/6	UL41 9/-	6K7G 4/6	813 50/-
EF98 11/-	PCC84 9/6	UL84 9/6	6K7GT 10/6	
EF99 10/-	PCF80	UY41 7/6		
EF91 5/-				

**SEND FOR LISTS.**

Quotations given for any types not listed. Obsolete and old types a speciality.

# TELEVISION TUBES REBUILT

A NEW GUN IN EVERY TUBE  
Buy direct from the factory!  
12 months' guarantee

12 inch - £5-0-0  
14 inch - £5-10-0  
17 inch - £6-10-0

Special terms to the trade

Carriage and insurance 12/6 extra

## ELECTRONIC MAINTENANCE SERVICES

131, St. Ann's Road, Tottenham, London, N.15 STAmford Hill 3267



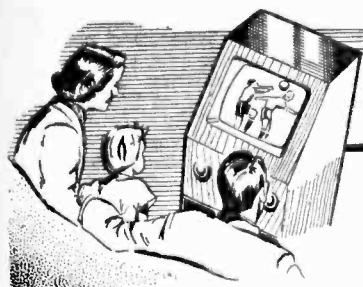

## UNDERNEATH THE DIPOLE

A MONTHLY COMMENTARY

By Iconos

### Off-Beat

THERE is plenty of publicity for teenagers these days. They are the pampered class, the target of novelists, newspapers, playwrights, film producers and television—especially television. I do not say that television exactly glorifies them—indeed, both BBC and ITV take pride in seeking out the most unsavoury teenage boys and girls and encouraging them to reveal their way of life *ad nauseum*. There are plenty of normal and healthy teenagers. But I suppose these normals are “squares” and therefore undramatic in the eyes of some of the crew-cut TV producers. Residents of Brighton were embarrassed by A.R.’s *Living for Kicks*, a skilfully-made documentary programme with Daniel Farson as interviewer. This was scarcely the right material for family circle viewing! This feature probably obtained good TAM ratings and therefore more stones will be pulled back in more towns to reveal the lower form of insect and human life. Unsavoury subjects at the theatre, music hall and cinema attract large audiences—but of a type that is transient. The displacement of these places of entertainment by supermarkets in many towns is an inevitable consequence. Let us hope that the BBC and ITA do not fall into the same trap. It would take very large supermarkets to displace Lime Grove and Wembley TV studios!

### Colour TV

COLOUR TV! The very mention of it sends an apprehensive shudder down the backs of the members of the appropriate Committees of the Government, BBC, television contractors and other interested parties. Colour TV has been a niggling ache to

them, and it is getting worse. Even after its introduction, troubles are bound to persist for a long time. Sooner or later, someone will have to make a decision on when it will be introduced, and what system of transmission will be used at the studios, transmitters and receivers. The BBC have been carrying out practical tests for some time at very great cost but with encouraging results. There are two or three colour systems which fulfil the requisites of the American N.T.S.C. standards. Demonstrations have been excellent—it makes black and white television flat and uninteresting by comparison. However, the increased costs of all transmission and receiving equipment, its maintenance and operation and finally, the large increase in scenic costume and similar costs, all mount up to delay the taking of decisions. How bitterly many British manufacturers and others regret the hasty re-adoption of

the 405 line standard after the war! Just a little delay and some trivial compensation for pre-war TV set owners who could prove that their sets still worked, would have enabled a fresh start to be made—possibly on 625 lines. However, that is all over and done with—but nobody wants a repetition of this kind of mistake when colour is introduced.

### Three-colour or Two-colour TV?

MOST modern systems of colour photography are based on a combination of three colours—yellow, cyan (a shade of blue-green) and magenta. With films or still transparencies, these three primary colour components of a scene are filtered into their respective photographic emulsions if three separate negatives are used (as in the original Technicolor 3-strip system) or self-filtered in three layers of photographic emulsion on the same base (as with Eastman Colour). A



Francis Coudrill operates “Hank”, his puppet, and his 16mm sound and picture camera for a TV feature.

similar kind of filtering is necessary in colour television. For really acceptable results on a large cinema screen, a three-colour system is considered to be essential for films: although quite good results have been obtained on film with two-colour processes by Technicolor—comparatively recent improvements upon the earlier two-colour systems of Prizmacolor, Kinemacolor and others. Of course, the fidelity of a two-colour system is less than those using three colours, but the costs and complications are very considerably reduced. The BBC are reputed to be experimenting with a two-colour system. If they find just the right combination of filters which will give reasonably consistent results without too much degradation, they might have a solution which is within the financial resources of TV programme companies and individual viewers. Three-colour TV costs more than three times black-and-white TV at both receiving and transmitting ends. Those who doubt the potentialities of a two-colour system should take a look at some of the excellent results attained with the earliest Technicolor films. A two-colour system was used by Technicolor more recently on the Olympic Games film made at Wembley about eight years ago.

### "China Doll"

The steadily increasing skill of ABC-TV's production department and technicians becomes apparent with every play in their *Armchair Theatre* series. Many of them are now produced and recorded on Ampex tape at ABC's new production centre at Teddington. Glossy technical qualities, first-rate lighting, imaginative set designs and first-class direction are their characteristics. It is a pity that the plays themselves sometimes fall below these high standards. *China Doll*, for instance, was a beautifully acted, superbly directed production of a dreary story about a middle-aged wife, neglected by her husband, who falls in love with a young, good-looking car salesman. The wife was very well played by Ursula Howells, who has not been seen on television for some time. Hugh Burden was the harassed husband, and Tom Gerard, a newcomer in his second TV play, was convincing as the handsome

salesman. But, like many other recent plays on both BBC and ITV channels, it was a pretty dreary and depressing affair. Almost the same remarks applied to the BBC's production of *The Fanatics*, Miles Malleon's play of the roaring twenties. The transmission of this play, which attracted and shocked large theatre audiences of that period, is now calmly put on in a Sunday evening programme by the BBC. The high technical qualities in this case can be credited to the BBC's Birmingham studio, with production by Terence Dudley.

### Master Controls

How complicated can master control systems become? There seems to be no limit. TWW is now operating a small temporary local news and interview studio in Bristol, the vision output of which can be injected into the coaxial line bringing the network programmes from London to TWW's master control at the Pontcanna Studios, Cardiff. This can be operated by remote control in Cardiff. The same will apply for the output from the very large stage now being built by TWW at Bristol. The programme switching in Anglia's beautifully engineered master control at Norwich is now automatically carried out by a steadily-moving punched tape. The output of the new Southern Television Studio at Dover is sent via London to Southampton Master Control, where it is

switched into the local and network programmes and sent back to the Dover ITA transmitter as well as Chillerton Down transmitter. The Dover Studio picture therefore travels over 400 miles of coaxial lines and radio links to get to its local transmitter, five or six miles distant!

### Hancock Back Again

Tony Hancock and Sydney James, their writers, Ray Galton and Alan Simpson, and their producer, Duncan Wood, have set such a high standard of character comedy entertainment that it must be difficult to maintain the pace and quality. The new series of *Hancock's Half Hour* began with an amusing little story of Hancock's cold in the head that was good but not quite up to form. The second episode, the adventures of the lugubrious Tony in the East Cheam Public library, was right back in top class again. Magnetic Videotape recording was used, which seemed to give better photographic qualities than previous episodes. The Crazy Gang returned to *Sunday Night at the London Palladium*—to the theatre where they first teamed up 28 years ago. Their united ages are said to add up to an astronomical figure, but the rather unkind camera work and lighting seemed to multiply that figure by two! Nevertheless, their robust humour provoked a lot of laughs and Bud Flanagan, the star clown, was in very good form.

## PRACTICAL WIRELESS

### Chief Contents of May Issue

### Now on Sale, 1/6

MAINS SHORT-WAVE TWO  
A TRANSISTORISED VOLTMETER  
100kc/s CHECK OSCILLATOR  
TRANSISTORISED TIMING UNIT  
A SINGLE-ENDED AMPLIFIER  
MINIATURE CRYSTAL CONTROLLED MAINS TX  
IMPROVING THE No. "19" SET  
BRIDGE FOR LOW RESISTANCE  
AVC FOR TAPE RECORDERS  
A.F. CALIBRATOR  
ETC., ETC., ETC.

# NEW! TAYLORMETER Model 127A

## 20,000 o.p.v. POCKET SIZE!

*Performance equal to a high priced instrument*

### OUTSTANDING FEATURES:

- ★ Sensitivity 20,000 o.p.v. D.C. 1,000 o.p.v. A.C.
- ★ 20 Ranges.
- ★ D.C. Current 50μA, to 1 Amp.
- ★ D.C. Volts 0.3 v. to 1,000 v. (25 kV by probe).
- ★ A.C. Volts 10 v. to 1,000 v.
- ★ 3 Resistance Ranges from 0-20 megohms (self-contained).
- ★ Meter 40μA 3½" arc.
- ★ Accuracy D.C. 3%, A.C. 4%.
- ★ Dimensions 5½" x 3½" x 1½".

**Price: £10.0.0**

**Credit Sale Terms available.**  
9 monthly instalments of  
£1.4.4.

Write for full details.

Complete with Instruction Manual and interchangeable test prods and clips. High quality leather case, if required, £2.18.0.  
H.V. Probe for 25 kV ... £4.0.9



**TAYLOR ELECTRICAL INSTRUMENTS LIMITED**  
MONTROSE AVENUE,  
SLOUGH, BUCKS.  
Telephone: Slough 21381  
Cables: Taylins, Slough

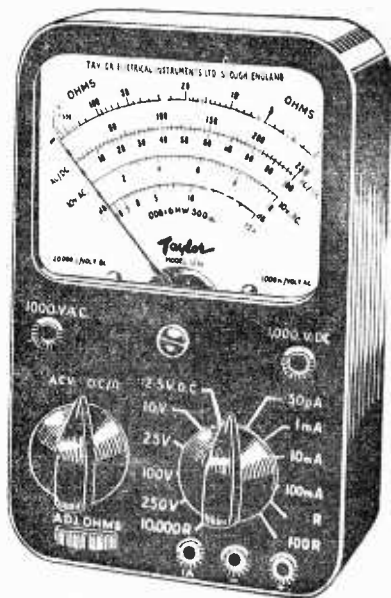

See us at the I.E.A. Exhibition, Olympia, May 23-28, Stand P.655

## An important announcement for users of Mullard products

On the 19th January 1960 injunctions were granted by the High Court of Justice, Chancery Division, to Mullard Ltd. restraining Bentley Acoustic Corporation Ltd. from:

- 1 Infringing the "Mullard" trade mark.
- 2 Passing off as valves of Mullard Ltd., valves not manufactured by Mullard Ltd.
- 3 Selling or offering for sale in connection with the "Mullard" name, valves not manufactured by Mullard Ltd.
- 4 Applying the "Mullard" name to valves so as to pass off inferior valves as of the quality marketed by Mullard Ltd. under the "Mullard" trade mark.

Bentley Acoustic Corporation Ltd. were also ordered to pay agreed sums in respect of damages and costs.

*This action was brought by Mullard Ltd. in the interests of the users of their products, and the Company wish to give notice that it is their intention to take action against any persons or companies who infringe their trade marks.*



MULLARD LIMITED • MULLARD HOUSE • TORRINGTON PLACE • LONDON W.C.1. MP 559B



# Trade News

## NEW PRODUCTS AND DEVELOPMENTS

### AERIALS

**T**WO new television aerials have been introduced by Wolsey Electronics Ltd. They are the Wolsey Loft Twin Super and the Wolsey Straight Three. The first is basically the same as the Twin Super Room Model but plastic covering is not used and a new type of rigid locking multi-plane ball joint has been affixed to the base. The Straight Three has a conventional Band I three element design. It is of standard gauge and quality and not a junior or light weight model. (*Wolsey Electronics Ltd., Cray Avenue, St. Mary Cray, Orpington, Kent.*)

### TWO NEW TV SETS

**T**WO new television receivers have been introduced by Stella Radio and Television Co. Ltd. They are the ST. 1017U 17in. and the ST. 1011U 21in. both fitted with a 110deg cathode ray tube and selling at 64 guineas and 79 guineas (tax paid) respectively. There is also a fringe version (ST. 2017U) of the 17in. set which sells at 68 guineas (tax paid). In both models the controls are set in a recessed side panel. The speaker at the opposite side of the set, also recessed, is conveniently angled towards the viewer. These two recesses make excellent hand-holds for carrying the receiver from room to room. A highlight of both models is a push-button on/off switch which enables the volume control to be pre-set. (*Stella Radio and Television Co., Ltd., Astra House, 121-123 Shaftesbury Avenue, London, W.C.2.*)

### STC SILICON RECTIFIERS

**A** NEW SenTerCel rectifier for the television industry has now been introduced by Standard Telephones and Cables Limited. Produced on specially-designed plant at the Company's Rectifier Division at Harlow, the new unit may be used to

replace the valve and the selenium rectifier from the high tension supply circuits of all TV receivers. Known as the FST1/4, the unit is a silicon semiconductor type with properties which make it especially suitable for compact receivers incorporating 110deg deflection cathode ray tubes. Two of the FST1/4 silicon rectifiers are necessary on 200/240V mains. For further information write to *Standard Telephones and Cables Ltd., Connaught House, Aldwych, London, W.C.2.*

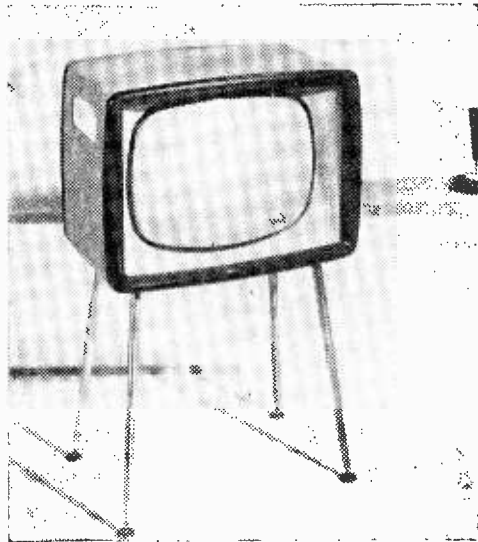

The Dynatron "Envoy" Model TV-45.

### TRANSPORTABLE TV

**A** NEW luxury styled 17in. transportable television receiver, to be known as the "Envoy", has recently been announced by Dynatron Radio Ltd. The Envoy incorporates a new 17in. 110deg aluminised tube. It has a 12 position turret tuner with coils fitted to cover ITA and BBC programmes, appropriate to the area in which the receiver is likely to be used. All 12 positions on the turret can be pre-tuned to cover any of the 13 channels which are allocated to television. Highly sensitive circuits counteract fading and, in areas of good reception, a telescopic aerial is provided as an optional extra. Frame fly-back suppression is provided to give increased latitude in the adjustment of viewing controls. An adjustable vision interference limiter prevents interference pulses exceeding peak white level on the screen. High quality sound is obtained by the

Two STC silicon power rectifiers with their valve and selenium counterparts for comparison.

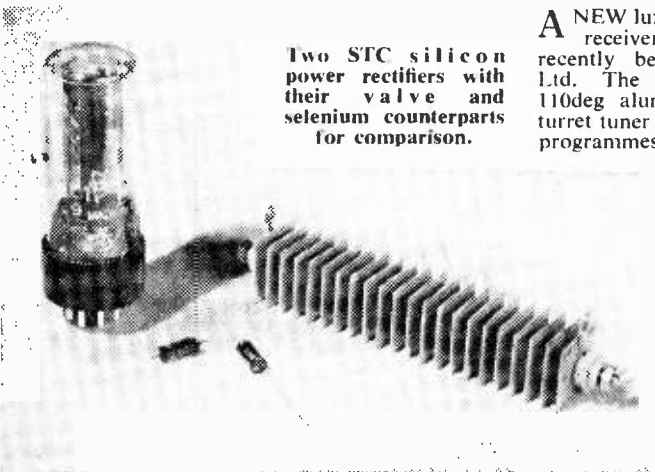

use of two side-facing 7in. x 4in. elliptical loud-speakers.

Two versions of the Envoy are available: Model TV45 for use in good reception areas, price 68 guineas; and Model TV45F which incorporates fly-wheel synchronisation for use in fringe areas. Both versions are housed in a wooden cabinet covered in pig-skin vynide, which is washable and highly durable. (*Dynatron Radio Ltd., Maidenhead, Berks.*)

### LABGEAR INSTRUMENT

THE Labgear Signal Strength Meter now includes Bands I, II and III having a frequency range covering channels 1-5, 8-12 and FM. Another

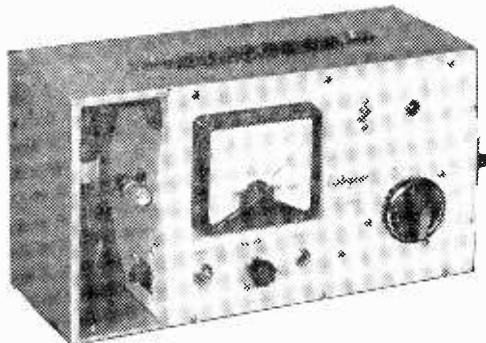

The Labgear  
Signal Strength Meter.

feature is a 4in. meter on which the signal intensity is directly calibrated. A 20dB attenuator pad is also supplied which, when fitted, multiplies the

### VALVE TESTER

(Continued from page 403)

set anode switch to position 1 and cathode switch to position 1 when the neon lamp should light. Then check the rest of the switch positions to make sure that the markings on the switches correspond with the valve pin positions. If possible use old valves to check that all circuits are working properly before using the tester normally. For all diodes, use S2 and position 6 and the meter should read about 3mA for full emission. Rectifiers use position 4 when the meter should read about 11mA. All valves are listed in a separate sheet giving switch positions and emission readings. For heater/cathode shorts the switch S9 is put to position 2 when no reading on the meter indicates no short. Cathode ray tubes can also be checked by making up an adaptor as shown in Fig. 8 using a 5 pin plug and plugging into the British 5 pin base on the tester, the other end of the lead connects to 12 pin CRT holder.

In operating the tester always put the switches to "off" when finishing especially the heater switches, and check the various switches after setting them before switching on the mains switch to ensure the correct voltages are applied to the heaters.

scale reading by 10 times so giving a coverage of from 10 $\mu$ V to 10mV. (*Labgear Ltd., Willow Place, Cambridge.*)

### SCREWDRIVERS

A NEW leaflet entitled "Screwdriver Know-how" has been produced by Stanley Works (G.B.) Ltd., and is designed for the general user and contains illustrated notes on the choice, use and care of screwdrivers. The full range of Stanley screwdrivers is described and a table of correct drilling sizes for holes for wood screws is also included. Inquiries should be made to the *Home Sales Department, Stanley Works (G.B.) Ltd., Rutland Road, Sheffield 3.*

### INDICATOR LAMPS

A NEW illustrated leaflet describing new types of "Acru" neon indicator lamps is now available. The lamps illustrated include types for M.E.S., M.C.C., S.B.C. and S.E.S. fittings. Festoon lamps are also produced which have low striking voltages. Certain of the lamps are available in fluorescent green as well as neon. Such devices form ideal indicator lamps for home-constructed electronic equipment and have the advantage of being economical in power consumption. Some types also give an indication of the applied voltage. The leaflet is available from *The Acru Electric Tool Manufacturing Co. Ltd., Demmings Road, Councillor Lane, Cheadle, Cheshire.*

### HEATHKIT CATALOGUE

THE latest catalogue produced by Daystrom Ltd. includes eight new kits. Copies of the catalogue may be obtained from *Daystrom Ltd., Gloucester.*

### TELEVISION TURNTABLE

(Continued from page 408)

M.S. tube (k) was used under the lower angle bracket to gain the correct clearance between the doors and the frame. The cover (h) was made from oak-faced ply and covers the aerial and electricity supply. These were brought down the wall and in through the slot in part (i).

The brick work was removed carefully and a lintel 5in. x 4in. fitted with wall plates as shown in Fig. 3. The framework of 5in x 2in. timber was assembled and at the same time the hinge pin, plates and hinge brackets, and spacer tube were fitted.

After cementing the gaps and plastering completed an architrave as on door of the room was fitted.

The turntable should be assembled in the framework before starting on the wall. Then, after fitting the framework to the wall, the turntable is reassembled.

To finish the turntable a clear varnish was used on the oak-faced ply, i.e. the insides of the doors and the table top. The reverse side of the doors and framework were painted to match the existing woodwork in each room.

# TELEVISION SPARES

**All Makes**

**All Models**

**By return of post**

LINE OUTPUT TRANSFORMERS      FRAME OUTPUT TRANSFORMERS  
DEFLECTOR COILS

LINE AND FRAME BLOCKING OSCILLATOR TRANSFORMERS

ALL POTENTIOMETER AND SLIDER CONTROLS

MAINS DROPPERS

METAL RECTIFIERS

GERMANIUM DIODES

FOCUS MAGNETS

ION TRAPS

E.H.T. CONDENSERS

Our Range of Spares is probably the most extensive in the country and includes all Spares for Tape Recorders, Radio and Record Player Units.

Technical Advice Free. Service Manuals supplied on loan.

Terms: C.W.O. or C.O.D. All Components are supplied at list prices, plus 2/6 p.p.

*Please enclose S.A.E. with all enquiries.*

## NEWBURY RADIO

272, ROMFORD ROAD, FOREST GATE, LONDON, E.7.

MARyland 3100

# Go buy Suffolk Tubes . . .

they're better!

EVERYTHING IN C.R.T.'s

REBUILT

RESCREENED

RE-ALUMINIZED



**SUFFOLK TUBES LTD**

SUFFOLK HALL 1-3 UPPER RICHMOND ROAD PUTNEY S.W.15

Tel: VANDyke 5267 and 4304

## New TV Tubes

RESCREENED NEW GUN C.R.T.S.  
EXACT PLUG-IN REPLACEMENTS  
CATHODES TRIPLE COATED  
LATEST SILVER SCREEN FOR  
BRILLIANCE

LARGE GETTERS FOR HIGH VACUUM  
FULLY GUARANTEED 12 MONTHS

We can supply replacements for—

Mullard, Mazda, Cathodeon, G.E.C., English Electric, Emiseone, Emitron.

12", 14"—£6/15/0

15", 16", 17"—£7

21", £8/10/0

24" £10

Carriage Free.

Trade Discount. 20 Weeks' Credit available.

## Express Electronics

281 PARLIAMENTARY RD., GLASGOW, C.4

Telephone: BEL 4569 BRI 7296

## TV AERIALS

Do-It-Yourself Kits Direct from Manufacturers.  
All Aerials pre-assembled for easy fitting.

Examples:

S/D +5 combined BBC, ITA Loft AE, £1.10.0.

S/D +5 combined BBC, ITA outdoor AE wall mounting complete, £2.13.6.

H +7 combined BBC, ITA with chimney lashing equipment, £4.13.0.

H +Double 6 super fringe combined BBC, ITA with 12ft. mast and chimney mounting kit, £10.10.0.

BBC loft AE 12/9. V.H.F. loft AE 11/3.

5 Element ITA AE for attaching to existing mast, £1.10.0.

5 Element ITA loft AE, £1.6.0.

8 Element ITA AE, £2.9.4.

Coax cable semi low loss, 7d. per yard, super low loss, 1/2 per yard.

Cross-over boxes for combining separate BBC and ITA Aerials, 9/6.

32ft. Garden Masts complete for erection, two sets guys, pickets, etc., with fitting instructions, £12.10.0.

Please send 6d. stamp for full list of aerials and accessories. Terms C.W.O. Orders over £4, post and packing free.

A. & L. ARNOLD LTD.

Midland Bank Chambers, Fore Street, Hertford.

## NYLON · P.T.F.E.

ROD, BAR, SHEET, TUBE, STRIP, WIRE

No Quantity too small  
List on application

ALUMINIUM, LIGHT ALLOYS,  
BRASS, COPPER, BRONZE

## H. ROLLET & CO., LTD.

6 CHESHAM PLACE, LONDON, S.W.1  
SLOane 3463

Works:

36 ROSEBERY AVE., LONDON, E.C.1.

Branches at Liverpool, Manchester,  
Birmingham, Leeds.

## Factory Rebuilt . . . Super TELEVISION TUBES

All types fitted with New Gun Assembly. Fully guaranteed 12 months.

Mullard, Mazda, etc.:

12 inch . . . . . £5.0.0

14/15 inch . . . . . £5.10.0

17 inch . . . . . £6.0.0

Carriage and insurance 12/6.

ALLOWANCE ON OLD TUBE.

C.W.O.

C.O.D. or Credit terms available.

S.A.E. for all enquiries.

K.V.A. ELECTRONICS (Dept. P/1)

38 Godstone Rd, Kenley, Surrey

## FIRST-CLASS TELEVISION and RADIO COURSES . . .

GET A CERTIFICATE!

After brief, intensely interesting study—undertaken at home in your spare time—YOU can secure your professional qualification or learn Servicing and Theory. Let us show you how!

### FREE GUIDE

The New Free Guide contains 132 pages of information of the greatest importance to those seeking such success compelling qualifications as A.M.Brit.I.R.E., City and Guilds Final Radio, P.M.G. Radio Amateurs' Exams., Gen. Cert. of Educ., London B.Sc. (Eng.), A. M. I. P. E., A. M. I. Mech. E., Draughtsmanship (all branches), etc., together with particulars of our remarkable Guarantee of

### SUCCESS OR NO FEE

Write now for your copy of this invaluable publication. It may well prove to be the turning point in your career.

FOUNDED 1885—OVER

150,000 SUCCESSSES—

NATIONAL INSTITUTE OF  
ENGINEERING  
(Dept. 462), 148, HOLBORN,  
LONDON, E.C.1.

S. Africa: P.O. Box 8417, Jo'burg.  
Australia: P.O. Box 4570, Melbourne.

## NEW VALVES!

Guaranteed Set Tested  
24 HOUR SERVICE

1R5, 1S5, 1T4, 3S4, 3V4, DAF91, DF91, DK91, DK92, DL92, DL94, SET of 4, 21/8, DAF96, DF96, DK96, DL96, SET of 4, 27/6.

1D5	7/6	DL33	8/8	PCL82	8/6
1R5	6/3	DL35	10/6	PCL83	13/8
1S5	4/9	DL92	6/3	PENA4	11/-
1T4	4/-	DL94	7/3	PEN36C	8/-
3S4	6/3	DL96	8/11	PL36	11/6
3V4	7/3	EBC41	7/11	PL38	14/6
5Y3GT	5/3	EBF80	8/-	PL61	9/-
5Z4G	6/-	ECC81	5/6	PL82	7/6
6K7G	7/6	ECC82	6/-	PL83	7/6
6S8G	6/9	ECC83	8/6	PY32	11/-
6GTG	6/3	ECC84	8/3	PY80	7/-
6SL7GT	6/-	ECC85	8/-	PY81	6/3
6SN7GT	4/6	ECP80	9/9	PY82	6/9
6V8C	5/-	ECH35	6/9	PY83	7/3
6V8GT	6/3	ECH42	8/6	U25	12/6
6X5GT	5/-	EGL50	7/9	UB26	11/-
12K7GT	5/6	EF41	8/8	U52	5/3
12K8GT	11/6	EF80	5/-	UABC80	7/6
12Q7GT	5/6	EF85	6/6	UAF42	9/-
3SL6GT	9/-	EP86	10/3	UBC41	7/6
3Z4GT	5/6	EP89	7/6	UBP80	8/6
AZ31	8/9	EL41	7/3	UCC84	12/9
B36	8/6	EL84	6/9	UCC85	7/6
CL33	12/6	EY81	8/6	UCP80	14/6
DAC32	9/9	EY86	8/-	UCH42	7/9
DAF91	5/6	EZ49	6/9	UCI81	8/-
DAF96	6/11	EZ41	7/6	UCL82	10/-
DF33	9/9	EZ80	6/3	UCL83	12/6
DF91	4/6	EZ81	7/-	UF41	8/3
DF96	6/11	EZ82	9/-	UF42	7/6
DH7	6/6	MU14	7/6	UF88	6/6
DK32	12/-	PCC84	7/6	UL41	7/6
DK91	6/3	PCC89	11/6	UL84	7/6
DK92	8/-	PCF80	7/-	UY21	11/-
DK96	6/11	PCF82	8/6	UY85	6/9
				VP4B	9/6

Postage 6d. per valve extra. Any Parcel Insured Against Damage in Transit 6d. extra. Any C.O.D. Parcel 2/6 extra.

Office address, no callers.  
**GERALD BERNARD**  
90 CARR MANOR AVENUE,  
LEEDS 17



# Letters to the Editor

*The Editor does not necessarily agree with the opinions expressed by his correspondents.*

**SPECIAL NOTE:** Will readers please note that we are unable to supply Service Sheets or Circuits of ex-Government apparatus, or of proprietary makes of commercial receivers. We regret that we are also unable to publish letters from readers seeking a source of supply of such apparatus.

## BARKHAUSEN EFFECT

**SIR,**—I was interested to read in your March issue about a reader who had hum bars on his screen, as I have had a similar effect, but in my case on the vertical scan. I also have found it impossible to remove the trouble and wonder whether any reader has helped Mr. Baddely and would perhaps be able to help me. The effect is one which, I believe, has been termed the Barkhausen effect, but I am not sure about this. It gives rise to a series of dark parallel lines running straight up the screen, from one side of the picture to the other. There are about 10 of these lines, which my wife has described as "Regency stripes". I thought at first they might have been due to the lead from the sync separator to the tube base, and I accordingly made this of very thin wire, then a piece of coaxial, but to no avail. Can it be due to any internal scanning coil effect or defect? Perhaps I may have the assistance of some reader who has experienced a similar fault. — G. J. WILDE (Stanmore).

## COLOUR TV

**SIR,**—The idea mooted by one G. Humberston in a recent issue would, I feel sure, find a most ready market amongst the general public. I cannot agree with the editorial footnote to this reader's letter, that there are already enough controls to adjust. Some time ago I had the pleasure of visiting a television studio and was intrigued by a set which was being used for monitoring. This was provided with controls, not the least interesting of which were, I was informed, known as "shading controls". These appeared to darken or lighten the upper or lower sections of a picture, or the right or left as desired, and I have seen many transmissions at home on which I would have been glad to have the control at hand. I do not think there can be too many controls, although they should, in the main, be out of reach. How lucky is the viewer or experimenter who has these controls available, as many of the pictures may be improved by this means, and added to the colour arrangement referred to. I am sure would prove most valuable.—F. de CERE (Hounslow).

## SAFE MODIFICATIONS

**SIR,**—I was most interested in the information in your April issue, under the above heading, and in view of the recent excitement which has been caused in the paraffin fire world. I think it is high time a review was made of all domestic equipment which is on the market, and which is a source of danger. It is not the first time I have read of TV sets bursting into flames, or people being killed whilst using a set. The tests to be applied to paraffin heaters are to be revised, but the makers and others say that this is not really necessary, as they have been on the market for years and this hullabaloo has only just come up. The same could be said for TV and radio sets which have a 'live' chassis, etc. Surely, there must be some standard of safety which should be adhered to with any apparatus which is plugged into the mains, be it A.C. or D.C., and it should not be necessary for the user to have to think before he does anything with or to the set. I would suggest that the first and most important thing is that it should be made imperative for the set maker to fit a mains isolating transformer. I know this would not work with a D.C. set, but there are now so few areas with D.C. that this could be ignored.—I. COBB (Manchester).

## VALVE TYPES

**SIR,**—I recently wrote to you concerning a fault in my Sobell receiver, and you suggested that I had a certain valve checked as this was probably the cause of the trouble. I removed the back and looked for the valve only to find that there was no such type in the set. I went very carefully over the entire chassis and, not being an enthusiast with valve lists, I went to my dealer who had had the set before and asked him if he knew the valve you mentioned. He looked up a service manual and told me where to find the valve, but on looking there was another valve in this position. When I taxed him, he told me he looked up his records and the valve was the cause of the trouble originally and had been replaced, but as he did not have one of the originals in stock he had used a replacement from another maker. I am sure he did the right thing, but many readers may be faced with the same difficulty, and I think that where such substitutions are made the dealer would do well to pin a card inside the cabinet giving details of such a modification—the same as the Services do with their equipment. It would also be a good plan for the dealer or the owner to fit one of these cards and to record the dates of all servicing or other troubles.—F. J. RINGE (Hampstead).



*Whilst we are always pleased to assist readers with their technical difficulties, we regret that we are unable to supply diagrams or provide instructions for modifying surplus equipment. We cannot supply alternative details for constructional articles which appear in these pages. WE CANNOT UNDERTAKE TO ANSWER QUERIES OVER THE TELEPHONE. The coupon from p. 440 must be attached to all Queries, and if a postal reply is required a stamped and addressed envelope must be enclosed.*

#### MARCONI VC152

The picture on my 21in. set will not stop rolling and I lose about  $\frac{1}{2}$ in. of the picture at the bottom. I do not have a service sheet for this set.—S. Stanray (Westcliff-on-Sea).

Your letter indicates that the picture can be made to roll downwards or upwards with the hold control but cannot be locked. This indicates lack of sync pulses or at least weakened sync pulses. You should therefore suspect the interlace diode (small metal rectifier) associated with the LN152 (ECL80) frame timebase valve, also the shunt 2-2M resistor. The LN152 should also be replaced as this may be causing the cramping at the bottom. If you cannot obtain a service sheet for the VC152 from one of our advertisers, obtain a sheet on the VC69 DAM which applies except for the tube type and focus circuit.

#### BUSH TV62

The fault on my television set displays the following symptoms. No raster, no H.T. boost. The sound is normal and the line whistle can be heard. A  $\frac{1}{2}$ in. arc can be drawn from the EHT but it is not very "fat". The tube, AW36-21, and valves PL81, ECC82, PY81, EY86 and PY82 (2) all tested and found o.k. except that the rectifiers are down a little. I have a circuit of the timebase unit.—G. Kaye (Edgbaston, Birmingham).

You do not say whether the EY86 lights up normally or not or whether the EHT was tested at the EY86 anode or the CRT cap. Also we are not sure of what is meant by H.T. boost. In view of this we would advise you to ensure first that the ion trap magnet is correctly aligned, that the EY86 does light up (if it does the boosted H.T. line must be in order). If it does not, remove the EHT clip from the CRT and note the effect. If the EY86 does not light up at all, check the 140pF width capacitor, the 3-3k resistor to pin 8 of the PL81 and the 1 $\mu$ F boost capacitor. Also check H.T. electrolytics.

#### FERGUSON 988T

Superimposed on the left hand side of the picture there appear three dark grey vertical lines each about  $\frac{1}{4}$ in. wide and the same distance apart, which do not alter by any adjustment of the contrast control. The tube is a rebuilt one giving a very good picture in every other respect.—J. Taylor (Letchworth, Herts.).

You should check the 0.01 $\mu$ F capacitor wired from pin 2 of the CRT base socket to chassis. This is probably open-circuited.

#### G.E.C. TV1746

The trouble on my set is sound on vision on Band I and Band III. I have tried the oscillator trimmer, etc., and also sound rejector on L22 but cannot remedy the fault. I have also tried attenuating the signal without result.—T. Pearson (Salford 6).

You should first check the 16+32 $\mu$ F electrolytic capacitor which decouples the H.T. of the sound A.F. and output stages. If this is in order, check by shunting a test capacitor (say 16 $\mu$ F) across each tag to chassis in turn. Check the H.T. decoupling 0.001 $\mu$ F, and the decoupling capacitor's generally. We assume the beehive type rotary capacitors in the centre of the I.F. chassis have not been disturbed.

#### PHILIPS 1236U-15

There is no EHT. The sound is good. I have had all the valves tested and they are O.K. I have had the EHT transformer out and it appears O.K. For continuity in the windings, the EY51 does not light up. I have tested the filament.—S. Pilling (Islington, N.7).

You should not suspect the transformer at this stage. If the PY80 and PL81 valves are in order, check H.T. to pin 8 of the PL81 (assuming there is no line whistle at all). If there is no H.T. present, check 6-8k resistor from H.T. to line blocking oscillator transformer and continuity of this winding. If there is a line whistle suspect EY51, EHT smoothing capacitor (on other side of transformer—disconnect top end) or tube (remove anode clip from tube).

#### ENGLISH ELECTRIC T30365

This set is giving good sound and picture but when it has been on for any length of time the picture will fade out, sometimes returning of its own accord. If the picture does not return I turn the brightness control on the front of the set and the picture will be O.K. for half an hour or so, but eventually fade out again. Also when the picture is present there are wide shadow lines similar to a venetian blind moving up and down at the back of the picture. I have replaced PL83 but it has made no difference. The sound is perfect.—A. Harper (Pontypridd).

You should check tuner valves PCC84 and PCF80 and the base connections of the EF80 valves. Also check the tuner switch contacts. The tube could be at fault, but this is less likely. The venetian blind effect is due to the reception of interfering signals, which the tuner is incapable of rejecting.

#### ARGOSY 21K40

My set, which is 18 months old, is needing constant adjustment of the line controls. The line

**REGUNDED**  
Television Tubes, 12 months' guarantee.  
12" to 14" £5.10.0. 15" to 17" £6. Carriage  
and insurance 10s. extra.

**SCOTCH RECORDING TAPE**  
1200' Reels—Standard 23/-  
1800' Reels—Extra Play 37/6.

**DUBLIER TYPE "C" CONTROL** £500K.  
6/6 each.

**CO-AXIAL CABLE**, semi-airspaced, 75  
ohms, 6d. yard.

**RECTIFIERS**  
RM1 5/3, RM2 6/9, RM3 7/6, RM4 13/6, RM5  
19/6, 14A86 19/6, 14A97 19/6, 14A100 19/6,  
LW7 17/6, 18RA 1-1-16-1 8/-, FC31 (14RA  
1-2-8-3) 22/6, RC10L (14RA 1-2-8-2) 16/6.

**METERS Panel Mounting (Round)**  
Moving Coil

F.S.D.	Res.	Scale	Size	Price
1 mA	150 ohms	0-100	3 1/2"	27/6
1 mA	75 ohms	0-100	3 1/2"	22/6
5 mA	0.0037 ohms	0-20	2"	9/-
500 microA	—	0-600	2 1/2"	15/6

**CONSOB BATTERY ELIMINATORS**  
Two separate units identical in size to the  
B128 and AD35 batteries, 1.5 v. L.T., 90 v.  
H.T. Suitable for the latest low consumption  
valves, fully stabilised. New in  
original cartons. Listed at 63/-. Price 37/6.  
Post 1/6.

**OSMOR JIFFY PUNCH**

Type 1	Hole size	1"	..	..	7/-
Type 2	..	..	..	..	5/-
Type 3	..	..	..	..	9/3

**ALPHA RADIO TERMS.**—Cash with order or C.O.D. Postage and Packing charges extra, as follows: Order value 10/- add 1/3; 20/- add 1/9; 40/- add 2/6; £5 add 3/6. Minimum C.O.D. Fee and Postage 3/-. For full terms of business see inside cover of our catalogue. Personal Shoppers 9 a.m. to 5 p.m. Monday to Friday. Saturday 10 a.m. to 1 p.m.

# ALPHA RADIO SUPPLY CO.

**VALVES GUARANTEED ALL TESTED BEFORE DESPATCH**

AZ1	10/-	GZ32	12/-	3S4	7/6
AZ31	10/-	PCC84	9/-	3V4	8/6
DAF96	8/9	PCC85	9/6	5Y3G	8/-
DF96	8/9	PCF80	9/6	5Z4G	9/-
DK96	8/9	PCL82	12/-	6AL5	9/6
DL96	8/9	PCL83	14/6	6F1	14/-
EAP42	10/6	PL36	13/6	6F15	14/-
EBC33	6/9	PL38	26/6	6J7G	6/6
EBC41	9/6	PL81	12/6	6K7G	3/6
ECC81	9/-	PL82	9/6	6K9G	6/6
ECC82	7/6	PL83	11/6	6K25	19/11
ECC83	9/-	PY32	17/6	6L6M	9/6
ECC84	10/-	PY81	8/6	6AM6	4/6
ECP80	12/-	PY82	7/-	6Q7G	7/6
ECC82	13/-	PZ30	19/11	6V8G	9/-
ECH42	9/6	TP25	10/-	6V6GT	7/9
ECH81	9/-	U25	15/-	6X5GT	7/-
ECL90	10/-	U26	12/6	7B6	10/6
EFL39	5/9	U37	26/6	7H7	9/-
EP41	9/9	U381	19/11	7S7	9/6
EP80	9/-	U991	29/10	7Y4	9/-
EP86	13/-	UAF49	9/6	10F1	15/-
EL33	14/-	UBC41	9/-	10P13	15/-
EL41	10/6	UCH42	10/6	12A17	7/6
EL42	10/6	UF41	9/-	12AX7	8/-
EL84	9/-	UL41	10/-	12AU7	9/6
EM34	9/6	UR8	26/6	20P1	26/6
EM80	10/-	UY1N	12/6	25A6G	10/6
EY51	10/-	UY41	7/6	25Z4G	9/6
EY86	10/-	1R5	7/6	27SU	19/11
EZ40	7/6	1S5	6/6	35L6GT	10/-
EZ81	7/-	1T4	6/-	35Z4GT	8/-

**OSMOR CHASSIS CUTTERS**

Type 1	Hole size 1/2" x 1/2"	..	19/9
Type 2	.. 1" x 1 1/2"	..	21/6
Type 3	.. 1 1/2" x 1 1/2"	..	24/9

**CONVERT YOUR RADIOGRAM** with one of these Modern Automatic Record Changer Units

Monarch UA8 4-speed automatic record changers with Ful-FI turnover crystal cartridge, £6.19.6. Carriage 3/6.  
Collaro Conquest 4-speed fully mixing changer complete with Studio "O" crystal cartridge, £7.19.6. Carriage 3/6.  
Garrard RC120/D Mark II, 4-speed unit manual control to enable records to be played singly, £8.19.6. Carriage 3/6.  
Garrard RC121, the latest 4-speed automatic record changer, £10.19.6. Carriage 3/6.

**REPANCO TRANSISTOR AMPLIFIER** and FEEDER UNIT CIRCUITS. Envelope 1/6. Post 4d.

**WIRELESS WORLD**, Guide to Broadcasting Stations. Twelfth Edition, 3/6. Post 4d.

**HIGH RESISTANCE HEADPHONES** 400 ohms. 13/6 pair.  
**LOW RESISTANCE HEADPHONES**, 120 ohms. 7/6 pair.

**RESISTORS**, Assorted, 100 for 12/6.

**CATALOGUE**

Our 1960 catalogue is now available. Please send 1/- in stamps for your copy.

**HEATER TRANSFORMERS**

All 240 v. input. 4 v. 3 amp. 10/-, 6.3 v. 1 amp. 6/9, 6.3 v. 3 amp. 10/-, 12.6 v. 1 amp. 5/9, 5 v. 2 amp. 10/-, 2 v. 3 amp. 8/3.

**103 LEEDS TERRACE, WINTOUN STREET, LEEDS, 7.**

**For Safety's Sake use AVO Prodclips**

Pat. No. 748811

...with Trigger-Action Spring-Loaded Clips

PRESS TRIGGER TO OPEN  
RELEASE TO GRIP

Safety first every time with these patented spring-loaded AVO Prodclips.

Cleverly designed for use as insulated prods. they are invaluable for reaching and holding test points which are difficult of access.

Suitable for use with AvoMeter, Multiminor and Avo Electronic Test Meter Leads.

**AVO LTD** · AVOCET HOUSE, 92-96 VAUXHALL BRIDGE ROAD, LONDON, S.W.1. (Victoria 3404 (12 lines))  
A MEMBER OF THE METAL INDUSTRIES GROUP OF COMPANIES.

**TV TUBES** Completely Remanufactured as new

Complete New Gun Assembly

New Base — Aluminized  
New Getters — New Screen  
— Regraphited

**COMPLETELY NEW TUBES EXCEPT THE GLASS**  
ALL MAKES AND TYPES FROM STOCK

12"	..	..	..	..	..	£5 17 6
14"	..	..	..	..	..	£6 10 0
15"—17"	..	..	..	..	..	£6 19 0

12 months NEW tube guarantee.  
C.W.O. or C.O.D. Carr. & Ins. 7/6 (passenger)  
**20/-** refunded on your old tube if returned in our container.  
The Finest Tubes. The Fastest Service

**LAWSON TUBES**  
156 PICKERSLEIGH ROAD, MALVERN WORCS. MAL 3798

**NEWNES Books on Television****INDUSTRIAL TELEVISION**

H. A. McGhee, Grad.I.E.E.

This important book for television engineers and for users of television industrially discusses the design and application of television equipment in industry, education and science. Fully covers television pick-up devices; design of equipments; underwater television; television microscopy; television telescopes; stereoscopic television plus a survey of typical applications and costs. Extensively illustrated. **15s. (16s. by post).**

**TELEVISION PRINCIPLES AND PRACTICE**

F. J. Camm

A practical and authoritative work on the underlying principles of television transmission and reception covering every aspect of this new science, including servicing and installation. An exhaustive dictionary of television terms is included and the work is fully indexed.

**2nd Edition. 25s. (26s. by post).****TV CONVERSION FOR I.T.A.**

C. E. Lotcho

A practical guide for radio dealers and servicing engineers giving details of converter units and full information for fitting them to a wide range of receivers produced by nearly 30 television manufacturers. Over 100 illustrations and circuit diagrams are used and in addition there are valuable chapters on conversion methods; aerials and interference and suppression.

**25. (26s. 3d. by post).****FROM ALL BOOKSELLERS**

... or, in case of difficulty, at the post rates shown from **GEORGE NEWNES LTD.**, Tower House, Southampton Street, London, W.C.2. (Write for full list of radio and television books).

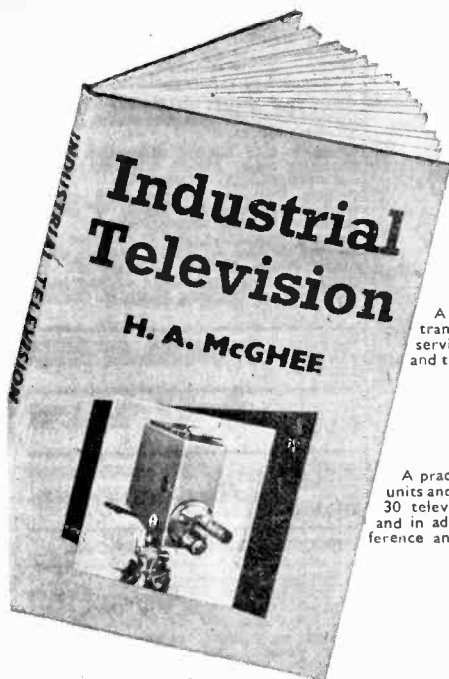
**NEWNES****BRAND NEW GUARANTEED VALVES**

**CHECK THESE PRICES AND SEE HOW WE CATER FOR THE CITIZEN'S POCKET**

DAF96	8/-	EF86	11/-	PY82	6/9
DF96	8/-	EL41	9/-	PY83	7/9
DK92	8/3	EL84	8/-	UAF42	9/-
DK96	8/3	EY51	9/6	UBF89	9/-
DL94	7/3	EY86	8/9	UCC85	7/9
DL96	8/-	PCC84	7/6	UCH42	9/-
EBC41	8/3	PCC85	11/-	UCH81	8/9
ECC81	5/9	PCF80	7/3	UF41	8/6
ECC82	6/3	PCF82	9/-	UF89	7/3
ECC83	6/9	PCL82	9/-	UL41	8/6
ECC84	8/6	PL36	14/-	U25	11/3
ECC85	8/6	PL81	9/9	IR5	6/9
ECC80	10/10	PL82	8/-	ISS	6/-
ECL80	8/3	PL83	7/9	IT4	5/-
EF80	6/3	PY81	6/6	354	6/6

Postage 6d. valve extra.

May we quote for obsolete and transmitting types? (S.A.E. please.)

**CITIZENS' VALVE SERVICE (REGD.)**

Office Address—No Callers :  
**103, GANTSHILL CRESCENT,  
ILFORD, ESSEX.**

**INRAXIA LTD.**

The Name for High Grade  
**REBUILT TUBES**

**ALL TYPES OF  
12" to 17"  
only £7/15/0**

**CARRIAGE FREE**

£1 allowed for old Tube

**12 MONTHS' GUARANTEE**

**INRAXIA LTD.,**  
65/66 Coleshill Street,  
**BIRMINGHAM, 4.**

\*Phone 1 ASTON CROSS 4815

**TRANSFORMERS**

Suppliers to B.B.C., I.T.A. and leading radio manufacturers, single or long runs, prompt delivery, home and export.

Rewinds to all makes

**H.W.FORREST(Transformers)Ltd.**  
Shirley, Solihull, Warwickshire.  
Tel.: SHI. 2483

**“AS-NU”****Regunned TV Tubes**

Supplied from stock and despatched by British Railways same day.

**COMPLETE NEW GUNS**

fitting in every tube and fully guaranteed for **TWELVE MONTHS.**

	Mullard	Mazda
12 in. ... ..	£4.15.0	£5.0.0
14 in. ... ..	£5.0.0	£5.10.0
15 in. ... ..	—	£6.5.0
16 in. ... ..	£6.10.0	—
17 in. ... ..	£6.0.0	£6.5.0
21 in. ... ..	£8.10.0	£8.10.0

Plus 10/- Carr. &amp; Ins.

Other types available. Please contact:

**J. P. WRIGHT**

1c Shotton Street, Doncaster

Sole Distribution Agent

\*Phone: DON 2636 or 66252

hold is very erratic, sometimes requiring many adjustments of the line hold control a dozen or so times during an evening and then it will hold good for several evenings with no bother. The picture is otherwise perfect. When it starts to slip, only the top third of the picture is affected and then after some seconds the whole picture has a shuttering effect with a change of line whistle which, if left, diminishes to a lower pitch in two or three stages till it is of very much lower frequency. I have tried substituting valves, sync separator, interlace diode, removing EHT connection with no effect. I have been wondering if it could be some of the smaller components associated with the valve V7B.—W. Barthwick (Liverpool 6).

The 21K40 differs in many respects from the 17K40. The line oscillator, for example, is an ECC82 and it is this valve which should be replaced and whose associated components should be checked.

#### MURPHY V150/B

I recently acquired the above set on the understanding that the sound was working but no picture. When I first switched on there was good sound and a raster, but no picture. After about half an hour smoke came out of the back and the set completely cut out. I tried the set again the following evening—no smoke this time—but sound and raster are still working.—A. Anderson (Coventry, Warwick.).

Without some further details we cannot give a specific reply, but suggest you check for charred components around the base of the valves in the sound I.F. stage. Replace any resistors burned out and their decoupling condensers, and also check the valve concerned for inter-electrode shorts.

#### DOVER TRANSMITTER

I have a Band III convertor tuned to Channel 9 London ITV. Will this converter tune to the new Dover transmitter which opened in December? I was unable to pick up the low power transmissions which were radiated for tests, not even sound. A few people I know picked up these test transmissions with the aerial still pointed in the direction of the London transmitter. Will I have to alter the coils for reception?—F. W. Angus (Canterbury).

You will have to unscrew the dust iron cores slightly to receive Channel 10, not however the I.F. output coil which remains tuned to the existing Band I channel. There is therefore three adjustments to make, the aerial, R.F. and oscillator coil cores, the latter, of course, being the most important and most critical.

#### STELLA ST6417U

The above set has run almost trouble free for 5 years, but as the tube was "low" I decided to renew it. My dealer supplied the MW43/69 instead of MW43/64 as he said it was a later tube and direct equivalent. Since fitting the tube the set suffers badly from a fault which did not exist before. Defocusing on peak white. When the contrast control is only slightly on it is a fair but "watery" picture. The slightest advance of the control makes peak white lettering, etc., blurred. As I assumed this was a tube fault I notified the dealer and he was good enough to let me try a further new tube, but with identical results. I have an

average knowledge of television and have delved into all the accepted cures for this fault but have had no success. Valves replaced include EY51, PL81, PY81 and EF80 (video amp). I have noticed that some new sets display this fault but not quite so badly as mine.—S. H. Sedle (Kidderminster, Worcs.).

We are inclined to suspect the video amplifier anode circuit decoupling capacitor which may well be open-circuited. The focus magnet may be defective but this is less likely.

#### AMBASSADOR TV5

I have been trying to repair the above set. There is no audible line whistle and no EHT. Before the screen went blank there were multiple horizontal pictures on it. I checked V14 20P1 by substitution with a known good valve. I renewed R79 and C56, checked R74, 76, 77, 78 and 83, C53, 54 and 55, had V15 U281 tested. I have finally renewed the line output transformer without much improvement. I have checked for line sync pulse at V11 anode with signal tracer and can hear it quite clearly. I checked C51 by substitution. The heater in the EY51 does glow faintly. I can draw a small spark from cathode and one about 3in. long from anode. There is still no line whistle. The EY51 heater glows the most with R79 set at minimum resistance. All I can obtain on the screen is a round patch of light on the bottom half extending just above half way. The H.T. output from metal rectifier is 250V. I have part of the complete circuit in February 1957 issue. In the component values, R76 is 270k, but when I checked this I found it was a 27k. Is this the correct value? Disconnecting EHT lead from tube does not improve matters.—G. V. Walker (Bilston, Staffs.).

We think that perhaps the insulation of the U281 heater winding on the mains transformer has partially broken down. Is it possible for you to check this with a megger? R76 is 270Ω (not 270k or 27k). Try the effect of putting a 270Ω across the existing R76.

#### FERRANTI 17T6

At the moment there is a 6in. black band across the centre of the picture, with a loud hum on the sound and distortion. I have replaced ECL80 frame output valve without result, and also checked the tube for faults. The picture is normal except for the black bar. I have had trouble with the turret tuner, but believe this is in order. I have been unable to obtain a maintenance sheet.—R. Hartley (Romford).

The fault is due to a heater-cathode short in the EF80 sound and vision I.F. amplifier (V3) next to the rear left side sensitivity control, or to a similar defect in the PCC84 tuner unit valve.

#### PETO SCOTT 1722

I have recently renewed the line output transformer and PY32 and EY86 valves but I am having trouble with EY80 repeatedly burning out. I have had three in three months. The first two were not new but the last was a new one. It lasted just four weeks.—C. Cooper (Basildon).

Check the width control to see if this is working. If it is not, check it and the series 22pF (12kV) capacitor to the PY81 cathode. There is an EHT regulator (line drive) control which is a 100k variable with a 0.1μF capacitor wired across it

(check both), also the 270pF to chassis in the PL81 control grid circuit.

### ALBA 321

The picture on this set has failed completely and the EHT rectifier tends to light brighter than normal. I pushed a piece of cardboard between the earthing clip which earths the coating round the tube. This restored the brightness to the tube face in a rough way but could not resolve a picture but could still control its brightness strength by the contrast control.—J. Davis (Nottingham).

We would advise you to replace the EY51 valve, restore the earthing clip and if the effect continues, suspect an internal short in the tube itself.

### ULTRA N84

I believe this is a fringe model. I wish to fit a Cyldon tuner E/16/L but am not quite sure which valves to take out to plug in the tuner. Would it be in order to fix it to the chassis despite the maker's instructions to fit it to the cabinet?—H. Hall (Cheltenham, Glos.).

There is no reason why the tuner should not directly connect to the chassis. In fact, it is essential for the two units to be well bonded together. The R.F. amplifier is the front left 6F1, the frequency changer is the second 6F1. The power plug of the Cyldon plugs into the R.F. socket, the I.F. plug into the frequency changer socket.

### FERRANTI 14H3

The first problem is serious overheating of the line output valve PL81, which becomes almost red hot after a few minutes. When I remove anode cap of either PL81 or PY81 it cools immediately to normal. The EHT transformer had short to heater winding of EY51, but otherwise no faults, but I have ordered a new one.

Could you give me wiring details for transformer also which one of two leads on the transformer tag board should go to PL81 and PY81? There is also a frame fault, causing fold-over at bottom and loss of height; height control is at limit.—G. Callin (Stirlingshire, Scotland).

Check 1.8k $\Omega$  resistor to pin 8 of the PL81. The heater winding of the EY51 could be hand wound with well-insulated wire, such as coaxial inner.

The L.O.T. should be numbered as follows: 6 to PL81 anode top cap; 5 to PY81 cathode top cap; 3 to scan coils, 0.5 $\mu$ F capacitor, 4.1M $\Omega$  resistor (to pin 10 of CRT), 15k $\Omega$  to 33k $\Omega$  (height circuit); 2 to resistors to horizontal holds; 1 to 22k $\Omega$  resistor to 4.7k $\Omega$  and PL81 control grid.

### EKCO TP308

Can you tell me the cause of the screech on the tuner of the above set? The 30L1 and 30C1 have been substituted three times with brand new valves but this still persists. This happens after an hour or two.—V. Jeremy (Merthyr Tydfil).

Sound I.F. instability is the usual cause of your trouble, and the makers' cure is to replace the 0.001 $\mu$ F which decouples the anode and screen of the 30F5, first sound I.F. valve. This component should be replaced by one of another type, but in exactly the same place.

### INVICTA 120T

The line hold on this set has been giving me trouble for some time. The control is turned fully clockwise. Any heavy interference pulses, or change of programmes make the picture break up into horizontal lines. I have to disconnect the aerial and then replace it to obtain the picture.—F. R. Knight (Lowestoft, Suffolk).

You will probably find that the ECL80 valve next to the line output section (just to the left of the tube) needs replacement. There is a preset horizontal hold beneath the chassis which could be reset, but replacement of the ECL80 will probably restore normal operation.

### HMV 1814

Can an Emiscope 3/16in. tube be fitted to the above receiver? The original tube Emiscope 3/31 has worn out and I have the 3/16in. tube complete with scanning coils and focus assembly. How do I reduce the EHT to a suitable value for the 3/16in. tube?—W. G. Denny (Ashford, Kent).

The EHT can be reduced by wiring a 0.001 $\mu$ F capacitor across the line scanning coils. This does however increase the width which may or may not be reduced by the width control. You may find it necessary to increase the resistance (940ohms) in the N152 (P181) cathode circuit (at present two 47ohm in series) to about 150ohms.

### PETO SCOTT T124

With a turret tuner added, the sound is perfect on Band I and III but there is no picture. I have tested the tube in another set and it is all right. The line output valve EL38 was flashing over and eventually went o.c. I substituted a new one but, after a while, this began arcing internally. I wired another valve in place of EL38 without making anode connection but this one did not burn out. The line whistle could be heard very faintly. The EHT spark is very small, about 1/32in. Could you suggest what to test? I have circuit only but no values of components.—P. A. Skepper (St. Helens, Lancs.).

The flashing in the EL38 probably denotes an internally shorted EY51 or a short associated with the line output transformer or scanning coils.

### BUSH 24C

The width control is at maximum and the picture is about  $\frac{1}{2}$ in. short of each side. The line linearity does not seem to work properly.—H. Partridge (Cradley, Staffs.).

The symptoms denote a failing valve. Check the PL81, the PY81 and the PY82 all on the left side of the main deck.

### QUERIES COUPON

This coupon is available until MAY 20th, 1960, and must accompany all Queries sent in accord with the notice on page 436.

PRACTICAL TELEVISION, MAY 1960.

# LINE OUTPUT TRANSFORMERS

Most types available. State Make and Model Number of Receiver when ordering.

S.A.E. please with all enquiries.

## HOWORTH

51 POLLARD LANE, BRADFORD, 2, YORKS  
Tel. 37030

# REBUILT TV TUBES

FULLY GUARANTEED 12 MONTHS  
Complete New Gun fitted in every Tube

12 in. ... .. £5.0.0	17 in. ... .. £6.10.0
14 in., 15 in. ... .. £5.10.0	21 in. ... .. £9.0.0

Immediate Delivery  
Carriage and Insurance 10/- extra

## NU-GUN TELETUBES LIMITED

3 The Mews, Duckett Rd., Harringay, London, N.4.  
Telephone: MOUNTview 2903

# REGUNNED TV TUBES

Supplied from stock and despatched by British Railways, same day. COMPLETE NEW MULLARD or SUPERIOR ELECTRON GUNS fitted in every tube, and fully guaranteed for 12 MONTHS FROM DATE OF INSTALLATION.

Mullard AW AND MW types available.

Mullard Mazda

12 in. -	£5.0.0	£5.0.0
14 in. -	£5.0.0	£5.0.0
15 in. -	—	£6.0.0
17 in. -	£6.0.0	£6.0.0
21 in. -	£8.0.0	£8.0.0

Carriage & Insurance 10/- extra.

Other types available; Brimar, E.E., G.E.C. etc. C.W.O. 10/-

## CLARKSONS (Tube Distributors)

120 Commercial Road, LEEDS 5

### B.B.C. - I.T.V. - F.M. AERIALS

B.B.C. (BAND 1). Tele-scopic loft, 18/6. External, S.D. 26/3.

I.T.V. (BAND 3). 3 Element loft array, 24/- 5 Element, 32/6. Wall mounting, 3 Element, 33/9. 5 Element, 41/3.

COMBINED B.B.C. + I.T.V. Loft 1+3 Element, 41/3. 1+5 Element, 48/9. Wall mounting, 1+3 Element, 56/3. 1+5 Element 63/9. Chimney and mast mounting units also available.

F.M. (BAND 3). Loft "H" 28/- 3 Element loft, 52/6. S/D loft, 12/6. External S.D. 26/3. State channel when ordering. C.W.O. or C.O.D. P.P. 2/6. Coaxial cable, 8d. vd. Coaxial plugs, 1/8. Send 6d. stamps for illustrated lists.

K.V.A. ELECTRONICS (Dept. T.P.)  
3B, Godstone Road, Kenley, Surrey

### COMPLETE CHASSIS SERVICE

Stock sizes: 6" x 4" 4/3; 8" x 6" 5/9; 10" x 7" 7/-; 12" x 6" 7/6; 12" x 8" 8/-; 14" x 10" 11/6. Please add 1/- to each order to cover part of postage.

Also special sizes and punched and drilled chassis to your own specification. Send S.A.E. for details. Trade enquiries invited.

'PJ' Products 34 High St., Erith, Kent.  
Mail Order only, please

A 3d. stamp will bring you a copy of our latest

### RADIO & TELEVISION COMPONENT Catalogue

JAMES H. MARTIN & CO.  
FINSTHWAITHE, NEWBY BRIDGE  
ULVERSTON, LANCs.

## A SUPER SPECIAL TV TUBE OFFER

Unused tubes made by world-famous manufacturers complete with 12 months' maker's guarantee. 17in. tube to replace the MW43-64 43-69, 171K, 172K, 17 ASP4, 17 AXP4, C17-1, C17-A, CR17-22, C17-FM, MW 43-80. Our Unbeatable Price £8.10.0. Also available brand new 14in. to replace 36-24, 36-44, TR14-21, TR14-22, 14 KP4A, 14-LP4, 141K, C36-24 or for AW 36-20, 36-21 12in. brand new 31 MW 31-74, all at £7 each. Also Cossor 65K 15in. 4 volt filament equivalent to TA15 or 85K by fitting 6 volt filament transformer 10 gns. Cossor 108K 10in. equivalent to EMI 3/16 £5.10.0. Ferranti 9in. T9/5 4 volt filament 50/- Post. packing & insurance 10/- extra.

## NEW MAX ELECTRONICS

for London's Finest Bargains in electronic and radio equipment. Also Largest Selection of Tape Recorders in the U.K. Also in stock 500 shop sold and H.P. reprocessed TV sets in all sizes. All Guaranteed.

220, Edgware Road, London, W.2.

Tel. PAD 5607

## RES/CAP. BRIDGE 37/-

p. & p. 2/-  
Checks all types of resistors, condensers 6 RANGES

Built in 1 hour. Direct reading

READY CALIBRATED  
Stamp for details of this and other kits.

RADIO MAIL (Dept. VY)  
Raleigh Mews, Raleigh Street, Nottingham

## SPECIAL VALVE OFFER

For Limited Period

EB91 4/-	UF42 8/6	6L1 8/-
ECL80 8/6	UL41 7/-	6L18 9/-
ECL82 9/-	UL44 7/6	6P23 6/6
EF90 5/-	UL46 7/0	6LD20 7/6
EF91 4/-	UBC41 7/0	6SN7GT 5/6
EL39 10/6	UCH42 7/6	7Q7 6/-
EY83 7/6	U35 4/0	10P1 8/-
GZ32 8/-	SP61 2/6	10P13 8/6
KT33C 0/8	3D6 2/6	10P14 8/6
KT36 8/6	6AT3 0/8	12AT7 6/-
PL33 8/-	6C16 7/-	20D1 7/6
PL82 7/6	6BG6G 10/6	20F2 8/6
PL83 7/6	6F1 0/-	20L1 8/6
PY80 7/-	6F13 6/-	20P1 9/6
EX82 7/-	6F14 6/-	807 6/-
PZ30 11/-	8Y16 0/-	185BT 12/6
UAF42 8/6	6J5GT 5/-	1625 6/-

Postage 4d. per Valve.

Air-Spaced Coaxial Cable, 75 ohms, 8d. vd. 10n Traps, 5/-; Midget 2 Gangs, 6/6; 24in. Flush Meters, 0-100 mA and 0-500 mA, 17/6.

TV AERIALS: We carry large stocks; send S.A.E. with your requirements and we shall reply and send leaflets by return.

### MAIL ORDER ONLY — NO CALLERS

Terms: C.W.O. or C.O.D., minimum C.O.D. 3/-; post age packing other than valves, under £2, 1/6; under £5, 2/-; aerials 2/5.

## ELECTRO SERVICES & CO.

221 BATTERSEA PARK RD., S.W.11

MaO. 6833/2

**HOLIDAY ACCOMMODATION**

**CASUAL WEEKENDS** or holidays. Try **RECULVER LODGE (P.T.)**, Bellinge, Kent.

**SETS & COMPONENTS**

**RECLAIMED VALVES.** EF50, 2/-; EF80, EL33, ECH35, T41, PEN45, N37, 5/-; EF91, EB91, 3/6; also many other types. Post free. C. & G., 42, Southfields Road, Littlehampton.

**REBUILT TV TUBES**

FULLY GUARANTEED 12 MONTHS  
ALL MAKES — 12" to 21"

**BLANE & MARTIN ELECTRONICS**  
**SANDOWN LANE**  
**LIVERPOOL**

Details on request. Tel. SEF. 3428

**TV TUBES** from stock. 17in. new gun £4/15/-, new gun and guaranteed; £5/15/-, 12 months' guarantee. **TV ELECTRIC & CYCLE CO.**, 1 High Street, Chalvey, Slough, Bucks. Tel.: Slough 21860.

**TV TUBES**

New: M.W. 36-24 £7/17/6.  
M.W. 43-64 £8/17/6.  
Re-gunned and re-screened:  
14in. Mullard £6/5/-,  
17in. Mullard £6/15/-.  
All tubes guaranteed for one year. Carriage and insurance 10/-. Orders despatched by Passenger train.

**KIRKGADE RADIO**

82 Kirkgate, Huddersfield. Tel.: 9601.

**TV ENTHUSIASTS** clearance. 75 valves, etc. Offers, carriage paid. Box No. 23.

**MULLARD TUBES**, reclaimed, 6 months' guarantee. 9in., 30/-, 12-14in., 59/6, 17in., 79/6. All picture tested. **FITTED FREE**. Picture shown to callers. Other makes, types, cheap. Salvaged spares for modern and obsolete sets. Prices from: LOT 17/6, FOT 7/6, Osc. Tr. 6/-, Mains Tr. 10/-. Valves: 1,000 types in stock. EF91, EB91, 6J5, 2/6, EF80, 10F1, UF42, 3/6. Save money. Send a S.A.E. with enquires or for free list. "ST. JOHN'S RADIO," 156, St. John's Hill, S.W.11. (BAT9838).

**LONDON TELEVISION**

**OFFER THE FOLLOWING BARGAINS. RIGIDLY TESTED EX-EQUIPMENT TELEVISION VALVES**, individually Boxed, 3/- to 7/6 each.

**WIDE ANGLE SCANNING TELEVISION CHASSIS**, Complete less valves. 30/- each. Most makes in stock.

**TELEVISION COMPONENTS** at Bargain prices. Please write for your individual requirements. Carr. extra. The undermentioned Televisions for Personal Callers Only.

14in. TELEVISIONS. Working £4/0/0 to £8/0/0. 17in. TELEVISIONS. £9/0/0 to £14/0/0. Trade enquiries invited.

4, HENDERSON ROAD, EASTNEY, PORTSMOUTH.

**RATES:** 4/- per line or part thereof, average key words to line, minimum 2 lines. Box No. 1/- extra. Advertisements must be prepaid and addressed to Advertisement Manager, "Practical Television," Tower House, Southampton St., Strand, London, W.C.2.

**SETS & COMPONENTS (continued)**

**NEW TUBES**

**TWELVE MONTHS' GUARANTEE**

12in. MW 31-16, 31-74	... ..	£5.19.6
14in. MW 36-24, 36-44	... ..	£7.0.0
17in. MW 43-64, 43-69	... ..	£8.0.0
17in. CRM 171, 172	... ..	£8.0.0

and Equivs. Carriage 7s. 6d.

**LINE OUTPUT TRANSFORMERS**

Direct Replacements for 500 sets.

Pye. LV30, 16T, CS17, etc. ...	..	50/-
18T, V4, etc., LV21, Luxury 17	... ..	60/-
Cossor. 930, 931, 933, 934, etc.	... ..	60/-
Baird. T29, T163	... ..	53/-
T164, T167, T172, 2014, 1712	... ..	60/-
Ferguson. 990T to 997T; 103T to 145T; 203T to 246T	... ..	66/6
Ekco. TS46; TS113-114; T161, 164; T222, 231; TSC311, etc.	... ..	55/-
Ferranti. 14T3, 17K3, 17T3	... ..	45/-
14T2, T1205, T1215, T1225, T1325, T1415, T1415, T1425, T1825	... ..	65/-
Invicta. T108 to T110	... ..	52/-
T101 to T104; T114 to T126; T133 to T142	... ..	60/-
Bush. TV 11A, B; 12A, B; TVF 12A TUG 12A, B; TRG 12A, B	... ..	45/-
TV12AM; TV22, 24; TRG24, TUG24	... ..	60/-
G.E.C. and H.M.V. mostly 55/- to	... ..	60/-

Add 2/6 post. S.A.E. with enquiries

**WESTWAY RADIO**

5 Westward Way, Harrow, Middlesex

**SALVAGED VALVES**  
2/6 each

Tested on Mullard High Speed Valve Tester

**New and Boxed Valves**  
all at 10/- each.

S.A.E. FOR LIST

ARION TELEVISION 4 Maxted Road, S.E.15  
NEWX 7152

**THE TELEVISION TUBE SHOP**

FOR FULLY REBUILT TELEVISION PICTURE TUBES

**TWELVE MONTHS GUARANTEE**

allowance on old tube

12in.	£4.10.0	
14in.	£4.10.0	
14in. round	£5.5.0	10/-
15in. round	£5.10.0	10/-
17in.	£5.10.0	10/-
21in.	£8.0.0	20/-

Carriage 5/-

57 guinea Model Tape Recorders for £45. 3 speeds, 4 1/2 watts. Really beautiful machines with Collaro "Studio" deck. £10 deposit. 48 Battersea Bridge Road, LONDON S.W.11. BATtersea 6859.

**SETS & COMPONENTS (continued)**

**GUARANTEED VALVES**

1L4	2/6	D77	3/6	PCF80	8/6
6F15	6/8	ECL80	7/6	PY80	8/6
6F15	7/6	EF80	5/-	PY82	8/6
10F1	6/8	EF91	3/-	SP61	6d.
20D1	6/6	EL32	3/-	UL46 1	7/6

All fully guaranteed for 3 months. Postage 6d. each. Send S.A.E. for list.

**SERVICE SHEETS, BOOKS, COMPONENTS.**  
Send stamp for lists.

**HAMILTON RADIO (T)**

237 Sedlescombe Road North, Hastings, Sussex. (Mail orders only)

17 INCH tubes £5, new guns, all sizes available, guaranteed. STAR TUBES, Brief Street, Bolton.

**RECLAIMED VALVES.** All tested and perfect; modern and obsolete; huge stocks: all one price. 5/-, plus 6d. postage each, delivery by return. LEWIS, 46 Woodford Avenue, Ilford, Essex.

**AERIALS AT TRADE PRICES**

For Example **DOUBLE FIVE ARRAY COSTS ONLY 60/-**

Band III Self-contained Pre-Amplifiers only £3.15.0. Band III Converters, 100/- Turret Tuners, 84/-. Complete Rebuilt T.V. Tubes from £5. Revacuumed ones. All Sizes, £2.10.0. All Tubes are Guaranteed. Super Low-loss Coaxial Cable, 1/1 yd. Standard, 6d. yd. Diplexers, 8/8 each. S.A.E. FOR FULL LISTS.

G. A. STRANGE, Broadkeld, North Wraxall, Nr. Chippenham, Wilts. Tel.: Marshkeld 236.

**TV TUBES**, factory rebuilt (re-gunned), fully guaranteed, 14in., £4, 17in., £5. p. and p. 10/-, 24, Bristol Road, Brighton.

**BRAYHEAD TURRET TUNERS** for any area. Will convert over 600 models. Complete with booklet and fitting instructions. State set and model No. when ordering. Carriage paid. 10m/c models 95/-, 16m/c and 35 m/c 120/-. C.W.O. or C.O.D. DURHAM SUPPLIES, 175, Durham Road, Bradford 8, Yorkshire.

12IN. TV'S 50/-, 9in., 45/-. Carr. Paid. Ex-Pte-Owners—not stripped of best valves, etc. complete, untested. COOPER'S, 53, Church Road, Birmingham 13. (No callers please).

**T/V SPARES**  
**LARGEST RANGE OF NEW AND USED SPARES**

Line Outputs our Speciality. Used from £1. New from 45/-. Also breaking hundreds of TVs for Spares. All Coils, Transformers, Chassis, Valves, etc. No Lists. Send S.A.E. and State Requirements for Immediate Quote.

**VALVE KITS.** A complete Kit for YOUR set (one of each type) from 50/-. Quote Model No. for exact price.

**TV BARGAINS.** Reconditioned. All channel Models at New Low Prices. 14in. from 22/6ns., 17in. from 29/6ns. Fully guaranteed. Terms available.

**T.C.S. LTD.** 112 Camberwell Road, S.E.5. Phone RODney 7917



**SETS & COMPONENTS (continued)**

**C. EDWARDS**

1070 HARROW ROAD  
LONDON, N.W.10  
LADBROKE 1734

Offers  
S/H TV in  
First-class  
Condition.  
12in. £5. 0.0.  
14in. £7.10.0.  
17in. £15. 0.0.  
(all 5 channel)  
+15/- carriage.  
Guaranteed  
VALVES



10F1, 10/-; 10C2,  
7/6; 20D1, 6/-;  
6F1, 5/-; SP61, 7/-; 6K25, 8/-; 20P1, 10/-;  
PZ30, 10/-; PL33, 7/-; ECL80, 8/-;  
EB91, 6/-; Plus 6d. post.  
S/H. 12in. Tubes, 50/-, plus 7/6 post.  
**FERGUSON, EKCO**

**TELEVISION TUBES!** Rebuilt, new  
guns, 12 months' guarantee. 12/14in.,  
70/-, 17in., 79/6. Quantity discounts.  
3 Park Avenue, New Barnet. BAR3185.

**TELEVISION TUBES**

**NEW TV TUBES. TWELVE Months**

	Guarantee	£.s.d.
12" MW 31-74	...	6. 0. 0
14" MW 36-24	...	7. 0. 0
17" MW 43-64	...	8. 0. 0
17" MW 43-69	...	8. 0. 0
Carriage	...	10/-

**FULLY Rebuilt TV Tubes TWELVE**

	Months Guarantee	£.s.d.
12" MW 31-74 CRM 123	...	5. 0. 0
14" MW 36-24 CRM 141	...	5.10. 0
17" AW 36-21 CRM 142	...	5.15. 0
17" MW 43-64 CRM 171	...	6.10. 0
17" MW 43-69 CRM 172	...	6.15. 0
17" MW 43-80 CRM 173	...	6.15. 0
21" MW 53-20 CRM 211	...	8.15. 0
21" MW 53-80 CRM 212	...	8.15. 0
15" CRM 152 CRM 153	...	6.10. 0

Carriage paid

**CATHODE RAY TUBE SERVICE**

35 Broomwood Road St. Paul's Cray  
Orpington 21285

**FOR SALE**

**USED VALVES** 5/- each, 6d. p.p. Z152,  
10F1, LN152, 6F1, Z77. Many others.  
Tested before dispatch. Delivery by  
return. R. JENKINS, 1 Winchendon  
Road, Fulham, London, S.W.6.

**VALVE CARTONS** at keen prices.  
Send 1/- for sample and list. J. & A.  
BOXMAKERS, 75a, Godwin Street,  
Bradford 1.

**100 BAYS** of brand new adjustable  
steel shelving, 72in. high x 34in. wide  
x 12in. deep, stove enamelled, dark  
green, sent unassembled, six-shelf bay,  
£3/15/-. Sample delivered free,  
quantity discounts. N. C. BROWN  
LTD, Eagle Steelworks, Heywood,  
Lancs. Tel.: 69018.

**FOR SALE (continued)**

**SERVICE SHEETS;** also Current and  
Obsolete Valves for sale. JOHN  
GILBERT RADIO, 20, Extension,  
Shepherds Bush Market, London,  
W.12. (Phone: SHE 3052).

**TELEVISIONS.** 12in., 14in., 17in. and  
Projections. Require attention, from  
£3. In working order—12in. BBC  
from £7. 14in. BBC/ITA with re-  
gained CRT from £18. 17in. from  
£25.  
Send for Lists. Carriage Paid.

**CADMAN'S**

Service Department, Bryan St.,  
Hanley, Stoke-on-Trent:

**MAKING YOUR OWN TELESCOPES.**  
Enlargers. Projectors. Viewers.  
Microscopes. Episcopes, etc., then  
our booklets, "How to Use Ex-Gov.  
Lenses and Prisms" Nos. 1 and 2,  
2/6 ea. will show you easily and  
quickly how to achieve the finest  
possible results at lowest possible  
cost. The most comprehensive lists  
of optical and scientific equipment  
in the British Isles is free for s.a.e  
H. W. ENGLISH, Rayleigh Road,  
Hutton, Brentwood Essex.

**1,000 TELEVISIONS,** all makes, from  
£3 working, 10/- not. Callers only.  
9 till 6, including Sats. 39, White-  
house Lane, Stepney, London.

**BAKELITE CABINETS** 5/9. Brand  
new. Colour brown. Attractive  
design. Size: 12in. x 7in. x 5 1/2in.  
Ideal for small receivers. P. and P.  
3/3. **COIL PACK SETS** 3/9. Bargain  
inc. 2w/band coil pack, 2 gang con-  
densers and pr. 465 I.F.'s. P. and P.  
2/3. **PRESS BUTTON COIL PACK**  
5/9. 3w/band F.M. gram. P. and P.  
1/6. **8IN. P.M. SPEAKER** 5/9. 2-5  
ohms Complete with O.P. Trans.  
10/-. P. and P. 2/9. — P.P.  
**COMPONENTS LTD.,** 219, Ilford Lane,  
Ilford, Essex. ILF 0295.  
Mail orders only.

**VALRADIO PROJECTOR** BBC 3 x 4  
screen speaker £25 o.n.o. Leytonstone  
1471.

**MISCELLANEOUS**

**LOUDSPEAKERS.** Electric Clocks  
and Shavers repaired promptly.  
**MODEL LOUDSPEAKER SERVICE.**  
Shipton on Cherwell, Oxford.

**PROTECT YOUR CAR AT NIGHT**

**"LITON"**

**PHOTOELECTRIC  
PARKING LIGHT  
SWITCH**

will switch your lights on at dusk—off  
at dawn, automatically, while you are  
at work, in bed, or away from home.  
Controlled by light. Transistorised.  
Avoid accidents, fines. Save your  
battery.

**KIT OF PARTS** 52/9  
**BUILT AND TESTED** 57/9  
Pat. Pending. Send 6d. stamp for pamphlet.  
"St. John's Radio," 156 St. John's  
Hill, S.W.11. BATtersea 9838

**WANTED**

**NEW VALVES WANTED.** — EY51,  
ECL80, PCC84, PCF80, PCL83, PL81,  
PCL82, PY81, R19, U801, 30P4, etc.  
Best cash prices by return. DURHAM  
SUPPLIES, 175, Durham Road,  
Bradford 8, Yorkshire.

**WANTED—VALVES.** Modern TV  
and radio types. Large or small  
quantities. Box No. 22.

**WANTED,** Service Sheets and  
Manuals. No quantity too large or  
too small; highest prices paid.  
SULTAN RADIO, 2, Stanley Road,  
Tunbridge Wells, Kent.

**NEW TV VALVES WANTED.** Send  
valves, cash by return to: P. J. F.  
Andrews, 61-63, Rosemary Road,  
London, S.E.15.

**A PROMPT CASH OFFER** for your  
surplus Brand New Valves. Speakers.  
Components. Test Instruments, etc.  
R.H.S., 155, Swan Arcade, Brad-  
ford, 1.

**PROJECTION TUBES** wanted new.  
MW/62. JOHNSTONE, Whichford,  
Shipston-on-Stour.

**EDUCATIONAL**

**INCORPORATED** Practical Radio  
Engineers' home study courses of  
radio and TV engineering are  
recognised by the trade as outstand-  
ing and authoritative. Moderate fees  
to a limited number of students  
only. Syllabus of Instructional Text  
free. "The Practical Radio Engin-  
eer" journal, sample copy 2/-, 6,000  
Alignment Peakes for Superhets. 5/9.  
Membership and Entry Conditions  
booklet 1/-, all post free from the  
SECRETARY, I.P.R.E., 20, Fairfield  
Road, London, N.8.

**STUDY RADIO, TELEVISION AND  
ELECTRONICS** with the world's  
largest home study organisation—  
I.C.S. Courses for the enthusiast  
and for those seeking examination  
qualification. Brit.I.R.E., City and  
Guilds, R.T.E.B., etc Build your  
own equipment with Practical Radio  
Course Write to-day for free book.  
**INTERNATIONAL CORRESPON-  
DENCE SCHOOLS,** Intertext House,  
Parkgate Road, (Dept. 516), London,  
S.W.11.

**\* LEARN \***

**RADIO & T/V  
SERVICING**

for your OWN  
**BUSINESS/HOBBY**

● by a new exciting no-maths,  
system, using practical equipment,  
recently introduced to this country.

**FREE Brochure from:—**

**RADIOSTRUCTOR**  
DEPT. G78, 40 RUSSELL STREET  
READING, BERKS. 5/60

(continued overleaf)

**EDUCATIONAL (continued)**

"HOW AND WHY" of Radio and Electronics made easy by a new, non-maths, practical way. Postal instructions based on hosts of experiments and equipment building carried out at home. New Courses bring enjoyment as well as knowledge of this fascinating subject. Free brochure from: Dept. 12 P.T., RADIO-STRUCTOR, 40, Russell St., Reading, Berks.

**SERVICE SHEETS**

**FAULTFINDER FILES (TV)** showing common faults that each receiver is prone to and other useful servicing information. 2/- ea. List 9d plus postage. S.P. DISTRIBUTORS, 11, Old Bond Street, London, W.1.

**SERVICE SHEETS.** TV 4/- ea. Radio 3/- ea. List 1/-. All orders dispatched on day received. C.O.D. if required. Also manuals for sale and hire. SULTAN RADIO, 29 Church Road, Tunbridge Wells, Kent.

**SERVICE SHEETS** for s.a.e. all types, from 1/-. Free Fault Finding Guide with all service sheets. 100 TV service Sheets covering 330 popular models. 18/6. Radio, TV, Electronic, Books. S.A.E. lists / enquiries. HAMILTON RADIO (T), 237, Sedlescombe Road N., Hastings.

**SERVICE SHEETS.** — We have the largest stock of Radio and TV Sheets in the country for sale at 4/- ea. 1960 Radio and Television Service Sheet List Now Ready. 1/-. Also Manuals for sale or hire. List 9d. S.A.E. please. Mail Order Only. S.P. DISTRIBUTORS, 11 Old Bond Street, London W.1.

**SERVICE SHEETS.** Radio, T.V., 5,000 models. Lists 1/-. S.A.E. enquiries. TELRAY, 11, Maudland Bk., Preston.

**SERVICE SHEETS.**—Huge stock at 4/- ea. List 1/-. Immediate delivery. GLOBE SUPPLIES, 33, Fairfield Close, Sidcup, Kent.

**APPOINTMENTS**

**WANTED 677 Trainee Engineers**

The Electricity Supply Industry has vacancies this year for 677 recruits to its engineering training schemes. They are required both by the Central Electricity Generating Board and by the 12 Area Electricity Boards.

**83 university graduates** are needed as graduate trainees. They should possess a degree in electrical or mechanical engineering of a British university.

**73 technical college graduates** are required as engineering trainees. They should possess a Diploma in Technology, a College Diploma, a Higher National Diploma or a Higher National Certificate in electrical or mechanical engineering.

**521 school-leavers** are needed as student apprentices. There are two levels of entry: for those who possess a good Ordinary level G.C.E., including passes in maths and science, and for those who have taken G.C.E. at "O" level and have also obtained passes in maths and physics at Advanced level.

Training for university and technical college graduates is by means of a planned two-year course of practical experience,

satisfying the requirements of the professional institutions.

Training for school-leavers is by means of a five-year apprenticeship, including day-release or a Sandwich Course, leading to a professional engineering qualification.

*On satisfactory completion of training, all trainees are guaranteed employment in this essential, expanding industry. A wide range of careers is available in many types of engineering — generation, transmission, distribution, commercial and research. Because the demand for electricity doubles every ten years, the prospects of promotion are good.*

For further information write to:

**The Education and Training Officer,  
The Electricity Council,  
154 Winsley Street,  
London, W.1**

**EDDY'S (NOTTM) LTD**  
172 ALFRETON ROAD, NOTTINGHAM

**HUGE PURCHASE!  
TRANSISTORS**

Red Spot, 4/6 each. Doz. Lots, 4/- each.  
White Spot, 6/6 each. Doz. Lots, 5/9 ea.

**VIBRATORS.** 12 volt, 4-pin, 4/11. Post 1/-.  
**2000mfd. CONDENSERS.** 6v. working, 1/6. Post 6d.  
**RECTIFIER/STABILISER** for 1.4 volt valves. Midget, 3/- Post 6d.

**SPECIAL OFFER!**

**CARRADIO KITS.** Seven Transistors. Long and Medium Waves 2 watts output. R.F. stage and automatic gain control. Complete kit with cabinet 10/- Gns. Speaker extra, 17/11. P. & P. 5/- Please state voltage. Size 7½ x 7½ x 2½in.

**10mfd. PAPER CONDENSERS.** Block. Ideal for crossover networks. 3/11 Post 1/3.  
**THROAT MIKES,** 1/- Post 6d. Could be used for electrifying musical instruments.  
**HEADPHONE CORDS.** High Quality 6ft. lengths, 1/11 pair. Post 6d.  
**GERMANIUM DIODES,** 9d. each. 8/- doz. Post 4d.  
**RECTIFIERS.** RM1 4/9; RM2 6/6; RM3 7/6; RM4 15/6; RM5 19/6. Contact Cooled Miniature 200v. 60 mA, 7/6. Post 1/-.  
**ACOS MIKES,** 25/6. Post 1/6.  
**CO-AXIAL CABLE.** Air spaced, suitable for TV fringe area, V.H.F., etc., 7½d. yd. Cut to any length. Post 1/3 doz. yards.  
**HAND MIKES.** Carbon, 3/11. Post 1/9.  
**CONDENSERS.** Tubular wire end (Not ex. Govt.) 8mfd. 450v. 1/9, 8-8 450v. 2/6, 16mfd. 450v. 2/9; 16-8 450v. 4/-; 16-16 450v. 3/9; 32mfd. 450v. 3/9; 32-32 350v. 4/- Post 1/-.  
**All Above are New and Guaranteed**

Surplus New and Guaranteed Values		
1A7GT 12/6	6V6GT 6/6	ECC85 8/6
1C5GT 10/6	6X5GT 6/6	ECF80 10/6
1D5 9/6	12A6 5/6	ECF82 10/6
1H5GT 9/9	12AT6 8/6	ECH42 8/9
1L4 3/9	12AT7 6/-	ECL90 9/6
1N5GT 9/9	12AU7 6/-	ECL82 10/6
1R5 6/6	12AX7 7/6	EF36 2/6
1S5 6/6	20D1 9/6	EF37 4/-
1T4 4/9	25A6G 8/-	EF40 13/6
2D21 4/6	25L6GT 9/-	EF41 8/6
3Q4 7/6	25Z4G 7/6	EF42 7/6
3Q5GT 8/9	35A5 12/6	EF50 1/9
5U4G 5/9	35L6GT 9/6	EF80 6/6
5Z4G 9/-	35W4 6/9	EF85 7/-
6AM6 4/6	35Z3 12/11	EF86 11/-
6AG5 5/-	35Z4G 7/6	EF89 8/-
6BA6 6/6	807(B) 3/9	EF91 4/-
6BB6 2/11	954 1/6	EL42 9/6
6B8J6 6/6	955 3/11	EL84 8/3
6C4 3/6	956 2/11	EY51 9/6
6CH6 9/6	AZ1 12/6	EY86 9/6
6F1 6/6	CL33 16/11	EZ40 7/9
6F6M 7/6	DAF96 8/3	EZ80 6/9
6F13 5/9	DF96 8/3	EZ81 8/6
6F15 8/6	DH63 7/6	GTIC 7/6
6F33 5/6	DH77 7/6	PCC84 8/6
6H6M 2/6	DK96 9/6	PCF80 9/-
6J5GT 3/6	DL96 8/3	PCL82 9/3
6J5M 4/3	DM70 7/6	PEN36C 9/6
6K7G 2/3	EAC91 5/3	PEN46 5/-
6K7M 7/6	EAF42 8/6	PL36 12/-
6K8G 6/6	EB34 1/6	PL81 11/6
6P25 9/-	EB41 7/-	PL82 7/9
6P28 9/6	EB91 4/-	PL83 8/9
6Q7G 7/6	EBC41 8/9	PY80 7/-
6SA7M 6/-	EBF80 8/6	PY81 8/6
6S7M 5/-	ECC40 19/11	PY82 6/11
6SK7GT 7/6	ECC81 6/-	PY31 8/6
6SN7GT 4/9	ECC82 7/-	UBC41 8/-
6V6G 5/9	ECC83 7/6	UY41 6/6
	ECC84 8/9	

Any parcel insured against damage in transit for only 6d. extra per order. All uninsured parcels at customers' risk. Post and packing 6d. per valve extra. Over £3 free. C.O.D. or C.W.O. only. C.O.D. charge 3/- extra. S.A.E. with all enquiries.

# Build your own Aerials...

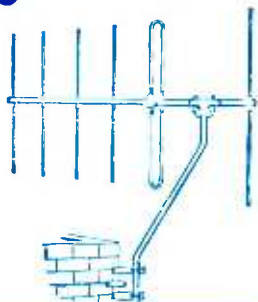

## AT HOME

AERIAL FITTINGS FOR BAND III, BAND I & RADIO F/M. Useful formulæ and hints for constructing your own aerial quickly and cheaply. Catalogue illustrating our increased range of Diecast Alloy Fittings, including Band III to Band I Mast Couplers, Reflector and Director Rod Holders, Insulators (both "Inline" and "H" types), Masthead Fittings, Masts and Elements, Chimney Brackets, etc. Send 1/- in stamps for the above, to:—

*Fringe*vision Ltd.

MARLBOROUGH, WILTS. Phone: 657 8

### AS ADVERTISED ON TELEVISION

Save £££

12 Months' Guarantee

## FACTORY REBUILT...

# TELEVISION TUBES

ALL TYPES AND SIZES—Immediate Delivery  
FITTED WITH COMPLETE NEW GUN

### Price

12" £5.12.6    14" £5.17.6    15" £6.5.0    17" £7.0.0  
21" £9.10.0

TERMS TO  
THE TRADE

Plus 10/- carriage and insurance.  
Cash with order or C.O.D.

## RE-VIEW (LONDON) LTD.

10 High Street

Colliers Wood, S.W.19

Telephone: Liberty 3272

**C.R.T. ISOLATION TRANSFORMERS**  
 TYPE A. OPTIONAL 25% and 50% BOOST.  
 2 V. OR 4 V. OR 6.3 V. OR 10.8 V. OR  
 13.3 V. 12.6. TAPPED MAINS INPUT.  
 TYPE A2. HIGH QUALITY LOW CAPACITY.  
 10.15 PF. OPTIONAL BOOST 25%, 50%,  
 75%, 16.6. TAPPED MAINS INPUT.  
 TYPE B. MAINS INPUT. MULTI OUTPUT 2,  
 4, 6.3, 7.5, 10 AND 13 VOLTS. BOOST 25%,  
 AND 50%. LOW CAPACITY, 21.-

**TRIMMERS.** Ceramic, 30, 50 70 pF, 9d., 100 pF,  
 150 pF, 1/3; 250 pF, 1/6; 500 pF, 750 pF, 1.9.  
**RESISTORS.** Preferred values, 10 ohms to 10 meg.,  
 1 w., 4d.; 1 w., 4d.; 1 w., 6d.; 1 1/2 w., 8d.; 2 w., 1.1.  
**HIGH STABILITY.** 1 w., 1%, 2.- Preferred values  
 100Ω to 10 10 meg. Ditto, 5%, 100Ω to 5 meg. 9d.  
 5 watt } 25 ohms—10000 ohms } 3  
 10 watt } }  
 15 watt } }  
 15,000 ohms—50,000 ohms, 5 w., 1.9; 10 w., 2.3.

**PLASTIC RECORDING TAPE**  
 Long Play 7in. Plastic reel, 1,700ft. ... 35/-  
 Long Play 5 1/2in. Plastic reel, 1,200ft. ... 29/-  
 Long Play 5in. Plastic reel, 850ft. ... 21/-  
 Long Play 3in. Plastic reel, 225ft. ... 7/-  
 Standard 7in. Plastic reel, 1,200ft. ... 21/-  
 Standard 5in. Plastic reel, 850ft. ... 15/-  
 "Instant" Bulk Tape Eraser and Head De-  
 fluxer, 200/250 v. A.C., 27/6. Leaflet, S.A.E.

**O.P. TRANSFORMERS.** Heavy Duty 50 mA, 4 d.  
 Multiratio, push-pull, 7/6. Miniature, 3/4, etc., 4/6.  
**L.F. CHOKES** 15 1/0 H. 60/65 mA, 5.- 10 H.  
 85 mA, 10/6; 10 H., 150 mA, 14.-

**MAINS TRANSFORMERS 200 250 v. A.C.**  
**STANDARD.** 250-0-250, 80 mA, 6.3 v., 3.5 a.  
 tapped 4 v. 4. Rectifier, 6.3 v. 1 a. 5 v. ... 22/6  
 2 a. or 4 v. 2. ditto, 350-0-350 ... 22/6  
**MINIATURE** 200 v., 20 mA, 6.3 v. 1 a. ... 10/6  
**MIDGET**, 220 v., 45 mA, 6.3 v. 2 a. ... 15/6  
**SMALL**, 250-0-250, 100 mA, 6.3 v., 3.5 a. 10 d.  
**STD.**, 250-0-250, 45 mA, 6.3 v., 3.5 a. 17/6  
**HEATER TRANS.** 6.3 v. 1 1/2 amp. ... 7/6  
 Ditto, tapped sec. 2, 4, 6.3 v., 1 1/2 amp. ... 8/6  
 Ditto, sec. 6.3 v. 3 amp. ... 10/6

**ALADDIN FORMERS** and core, 4in., 8d.; 3in., 10d.-  
 0.3in. **FORMERS** 5357 and cans TV1 2, 2in. sq. x  
 2in. and 3in. x 1 1/2in. 2/- ea. with covers.  
**TYANA.** Midget Soldering Iron, 230 v., 40 w., 16/9.  
**REMPLOY Instrument** Iron, 230 v., 25 w., 17/6.  
**MAINS DROPPERS.** 3in. x 1 1/2in. Alu. Sliders,  
 0.5 amp., 1,000 ohms, 4/8. 0.2 amp., 1,000 ohms, 4/3.  
**LINE CORD.** 0.3 amp., 60 ohms per ft., 0.2 amp., 100  
 ohms per ft., 2-way, 6d. per ft., 3-way, 7d. per ft.  
**LOUDSPEAKER P.M. 3 OHM.** 5in. Rola, 17/6.  
 8in. Plessey, 19/6. 6in. x 4in. Rola, 18/-  
 6 1/2in. Rola, 19/6. 10 x 6in., 27/6. 10in. Rola, 30/-  
 4in. Hi-Fi Tweeter, 25.- 12in. H.A., 30/-  
 14 x 8in., 45/- 12in. 15 ohm, 10 Plessey, 45/-  
**STENTORIAN HF 1012** 10 in. 3 to 15 ohm, 10 w., 95/-  
 12in. Baker 15 watt 3 ohms, or 15 ohms, 105/-  
**CRYSTAL DIODE G.E.C.** 2.- GEX34, 4.-  
**HIGH RESISTANCE PHONES.** 4 ohm, 18/6 per pair.  
**MIKE TRANS.** 10 1/2 x 3 1/2 in. 100Ω. Ported, 10/6.  
**SWITCH CLEANER.** Fluid squirt sprout, 4 3/4 in.  
**TWIN GANG TUNING CONDENSERS.** 365 pF  
 miniature lin. x 1 1/2in. 10.- 0.0005 standard  
 with trimmers, 9/- less trimmers, 8/- midget, 7/6.  
**SINGLE.** 50 pF, 2/6; 75 pF, 100 pF, 160 pF, 7/-  
 Solid dielectric 100, 300, 500 pF, 3/6.  
**SPEAKER FRET, GOLD CLOTH.** 17in. x 20in. 5.-  
 25in. x 35in., 10.- Tyrax 4in. 6in. wide, 10/-; 2in.  
 3in. wide, 5/- ft. Samples S.A.E.

New and Boxed VALVES 90-day Guarantee.

115	7 6BK4	7 6EAB80	8 6HAB80	
185	7 6C4G	10 6EH91	6 6	10 6
174	6 6NTM	6 6E1B33	8 6HAB2A	6 6
282	3 6GQ74	7 6EBC41	8 6M11	9 6
384	7 6BSA7	6 6E1P80	10 6P91	3 6
374	7 6E67M	6 6E1C84	8 6E1P82	9 6
174	7 6E67M	9 6E1P50	10 6	9 6
173	7 6BSAG	7 6E1I42	10 6E1P82	11 6
524	9 6E6X4	7 6E1C82	10 6E1P25	6 6
6AM6	5 6E6X5	6 6E1P30	5 6E1P22	10 6
6H8	5 6E1A77	8 6E1P41	6 6E1P80	7 6
119E	7 6E1C87	9 6E1P39	8 6E1P82	9 6
6H16	10 6E1A78	8 6E1P50	5 6E1P82	7 6
6W6	10 6E1B68	10 6E1P80	7 6E1P81	3 6
1D6	6 6E1K7	6 6E1P91	5 6E1P81	10 6
6F6	7 6E1Q7	6 6E1P82	8 6E1I42	10 6
6E6	3 6E1L6	6 6E1P82	5 6E1I41	9 6
6E5	3 6E1QZ4	7 6E1S84	8 6E1I41	9 6
6J6	6 6E89	10 6E1M1	9 6E1I42	8 6
6G7	6 6E80	5 6E240	7 6E1Y2	8 6
6K6GT	6 6E954	1 6E280	7 6E1R105	8 6
6K7G	5 6E1A50	1 6E1E48	1 6E1R150	8 6

# TELEVISION REPLACEMENT LINE OUTPUT TRANSFORMERS

70 - ea. from stock.

For Makes and Models  
**Argosy:** T2, CTV517. **Decca:** D17 & C. **Defiant:** TR1753.  
**RGD:** 6017T, 7017C, C54.  
**Regentone:** 17C, 17T, 17 Comb.

**Argosy:** T3. **Decca:** D14.  
**Defiant:** TR1453T. **Regentone:** 14T. **RGD:** 6014T.  
**Marconi:** VT63DA.

**Baird:** 2014, 2017, 2114, 2117.  
**Cossor:** 930 & T, 931, 933-4-5, 937, 938 & A. & F. 939 & A & F, 943T, 946.

**H.M.V.:** 1824 & A, 1825 & A, 1826 & A, 1827 & A, 1829 & A, 1865, 1869.

**Marconi:** VT68DA, VT69DA.

**Sobell:** TS17, T.346.  
**Ferguson:** 306T, 308T.  
 Other makes available (7 days).  
 S.A.E. with enquiries.

## LINE BLOCKING TRANSFORMERS, 10" to 16 6.

**FRAME BLOCKING TRANSFORMERS, 13 6 to 21-**  
**FRAME OUTPUT TRANSFORMERS, 27 6 to 39 6.**  
 Most makes available (7 days).  
 S.A.E. with all enquiries.

## TV and RADIO SERVICE SHEETS, 1,500 models. Send 2 6, your Model No. and S.A.E.

**HIGH GAIN TV PRE-AMP KITS BAND I BBC**  
 Tunable channels 1 to 5. Gain 18dB. E.C.S.A. valve. Kit price 29/6 or 49/6 with power pack. Details 6d. (P.C.S.A. valves if preferred.)  
**BAND III ITA**—Same prices.  
**CRYSTAL MIKE INSERT** by Acos, precision engineered. Size only 2 in. x 3 1/2 in. 6/6.

**ALUMINIUM CHASSIS.** 18 swg. modified. With 4 sides, riveted corners and lattice fixing holes. 2 1/2in. sides, 7 x 4 in., 4 6; 9 x 7 in., 5 9 1 1/2 x 7 in., 6 9; 13 x 9 in., 8 6; 14 x 11 in., 10 6 1 1/2 x 14 in., 12 6; 18 x 16 x 3 in., 16 6.

**TELETRON "TRANSIDYNE"**  
**MIDGET SUPERHEAT PORTABLE** 6" x 4" x 1 1/2" 6 transistors, printed circuit, Ferrite aerial. All parts and cabinet, 211.18/6. We include **Edison Transistors** for maximum performance. Details 9d.

**B3C TRANSISTOR RADIO.** Med. and Long Wave. Complete kit, 22 6, photos 7 6 extra. Best Aid Experiences with Special Lead 15.- Details 6d.

## GARRARD TA MK II SINGLE PLAYER

### AUDIO PERFECTION

Designed to play 16, 33, 45, 78 r.p.m. Records 7in., 10in., 12in. Lightweight Xtal pick-up. GCS plug-in head. Auto stop. Stereo-wired.

**OUR PRICE £8.10.** each. Post Free (Stereo Heads £2 extra).

Model 4HF TRANSCRIPTION QUALITY. With Plug-in Normal Heads, £18.00. (Stereo Heads £2 extra).

**Volume Controls 80** ohm **COAX** Cable  
 Long spindles. Guaranteed 1 year. Midget 5K ohms to 2 Meg. No Sw. Linear or Log Tracks. Post 1d. per yard extra. Semi-air, spaced. 1in. dia. Losses cut 6d. yd. Fringe Quality. Air Spaced. 1/- yd.

**COAX PLUGS 1/- LEAD SOCKET 2/-**  
**PANEL SOCKETS 1/- OUTLET BOXES 4/6**  
**BALANCED TWIN FEEDER Yd. 6d.** 50 or 300 ohms. DITTO SCREENED per yd. 1.8. 80 ohms only. **WIRE-WOUND POTS, 3 WATT.** Pre-set. Min. Ty Type. All values 5 ohms to 25 K. 5 K. 30 K. 4/- (Carbon 30 K. to 2 meg., 3-1) **WIRE-WOUND 4 WATT.** Pots Long Spindle Values, 100 ohms to 50 K, 6/8; 100 K, 7/8.

**CONDENSERS.** New Stock. 0.001 mfd., 7 K; 1.4, 5 8; Ditto, 20 KV, 9/8; 0.1 mfd., 9 V; Tubular 500 v., 1000 to 0.05 mfd., 9d.; 0.1, 1/2, 0.25, 1.8; 0.5-500 v., 1/8; 0.1/350 v., 9d.; 0.01/2,000 v., 0.1/1,000 v., 1/8; 0.1 mfd., 2,000 volts, 3/8. **CERAMIC CONDS.** 500 v., 0.3 pF to 0.01 mfd., 9d. **SILVER MICA CONDENSERS.** 10<sup>5</sup> 5 pF to 500 pF, 1.2-500 pF to 47 pF, 1/8. Ditto 1/4, 50 pF to 815 pF, 1/9; 1,000 pF to 5,000 pF, 2/-.

**I.F. TRANSFORMERS 7 6 pair**  
 465 Kcs Sine Tuning Miniature Can. 2 1/2 in. x 1 in. x 1 in. High Q and good bandwidth. By Pye Radio. Data sheet supplied.  
 Weaire M800 I.F. 465 Kcs 12 6 per pair. Weaire 500 I.F. 465 Kcs 12 6 per pair.

**NEW ELECTROLYTICS. FAMOUS MAKES**  
**TUBULAR TUBULAR CAN TYPES**  
 1/350v. 2/- 50/350v. 5/8 1/500v. 3/-  
 2/450v. 2/8 100/25v. 2/- 15/500v. 4/-  
 4/450v. 2/8 250/25v. 2/8 325/50v. 4/-  
 8/450v. 2/8 500/12v. 3/100/270. 5/6  
 8/500v. 2/8 8 x 450v. 4/6 3,500/3v. 4/-  
 16/450v. 3/8 8 x 500v. 5 5,000/6v. 5/-  
 16/500v. 4/ 8 x 16/450v. 5 3/2 x 32/350v. 4/6  
 32/430v. 5/6 8 x 16/450v. 5 6/30 x 50/350v. 7/-  
 25/25v. 1/8 16 x 16/450v. 5/6 1/4 x 120/275v. 7/8  
 50/25v. 2/16 16/300v. 6 1/4 x 120/320v. 11/6  
 50/50v. 2/32 32 x 350v. 4 6/10 x 200/275v. 12/6

**LATEST EMI 4-SPEED SINGLE RECORD PLAYER.** Acos 78 high stereo and normal crystal pick-up. Silent motor, highly tunable. Special Offer, 88.19/6. Post 3/6.

**MAINS TYPE SELENIUM** 300 v., 85 mA, 7/8.  
**CONTACT COOLED** 250 v., 30 mA, 7/8; 60 mA, 8/6; 85 mA, 9/6; 200 mA, 21/-; 300 mA, 27/8.  
**COILS** Woorite "1" type, 3/- each. Osamor Midget "Q" type, add core from 4/-. All ranges. **TELETRON.** L & Med. T.R.F., with reaction 3/6. **FERRITE ROD AERIALS.** M.W. 8 9 M & L, 12/6. **T.R.F. COILS A/H/P.** 7/- pair. H.F. CHOKES, 2 6. **FERRITE ROD.** 7in. x 2in., dia., 2 6.

**JASON F.M. TUNER COIL SET, 26/-.** H.F. coil, aerial coil. Oscillator coil, two I.F. trans., 10.7 Mcs. Ratio Detector and heater choke. Circuit book using four 6AM6, 2/6.  
**COMPLETE JASON F.M. KIT WITH VALVES.** 26.5/0. Model FMT1.

**FULL WAVE BRIDGE SELENIUM RECTIFIER.** 300 v., 15 v. 150 mA, 5 9 2 1/2 in. x 1 1/2 in. x 1 1/2 in. **CHASSIS TRANSFORMERS.** Copper, input 200/250 v. for charging at 3 6 or 12 v., 1 1/2 amp., 15 6 2 amp., 17 6; 4 amp., 22 6. Circuit in **VALVE and TV TUBE** equivalent books, 5/- **TOGGLE SWITCHES.** 2, 2 - 1 P. 3/6. D.P.D.T. 4/- **WAVELENGTH SWITCHES** 4 6  
 5 v. 4-way 2 water long spindle 4 6  
 2 p. 2-way, or 3 p. 2-way short spindle 3 6  
 2 p. 3-way, 4 p. 2-way, 4 p. 3-way long spindle 3 6  
 3 p. 4-way, or 1 p. 12-way long spindle 3 6  
**VALVE HOLDERS.** Pax. Inv. 7d., 4d. **EP50, FA 50, 6d.** H12A, H12T, 1 3. Enr. and Amer. 4, 5, and 7 pin, 1/- **MOULDED MAZDA** and Int. Oct., 6d. **B7G, 18A, B8G, B9A,** 9d. **B7G** with can., 1/6. **B9A** with can., 1/6. **CERAMIC EP50, H7G, B9A.** Int. Oct., 1/- **S/CANS B7G, B9A,** 1/- ea.

**OUR ONLY ADDRESS**  
**337 WHITEHORSE RD., WEST CROYDON**  
 THO 1665. Buses 133 or 68

# 100 COMPONENT SPECIALISTS

Post and Packing 1/-, over £2 free. (Freight post Extra.) C.O.D. 1/6. (Wed. 1 p.m.)